

Compare Intel Xeon E7-4800v2 4-socket 4U x86 rack servers

GE-link to this document: <http://www.goldeneggs.fi/documents/GE-COMP-E74800V2-A.pdf>

Ivy Bridge-EX
2500MHz 15-Core

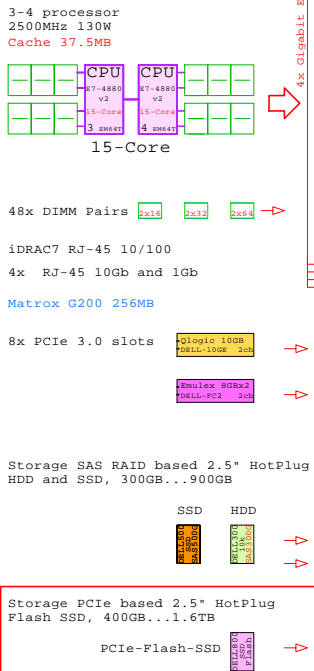

DELL

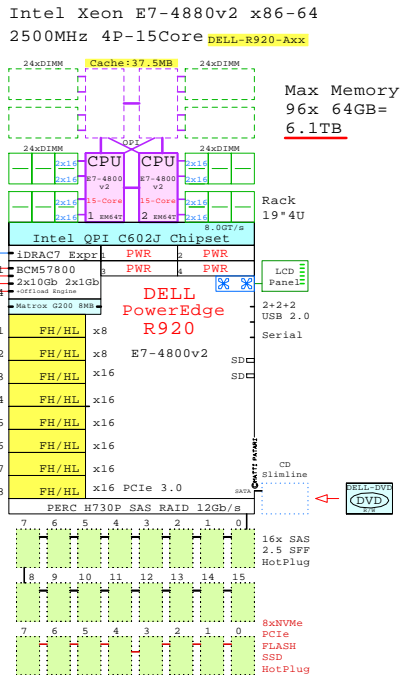

<http://www.goldeneggs.fi/documents/GE-DELL-R920-A.pdf>
Link to the detailed R920 GE-document.

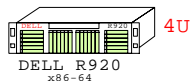

-4x CPU and Memory on Motherboard
-24xDrives, 2.5"

HP

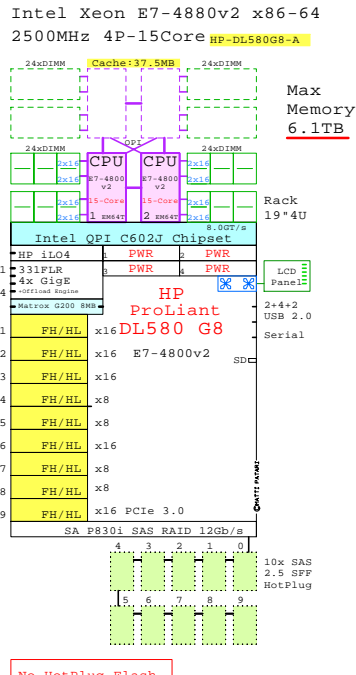

<http://www.goldeneggs.fi/documents/GE-HP-DL580G8-A.pdf>

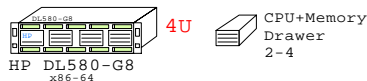

-4x Compute Drawers for CPU + Memory
-10xDrives, 2.5"

IBM

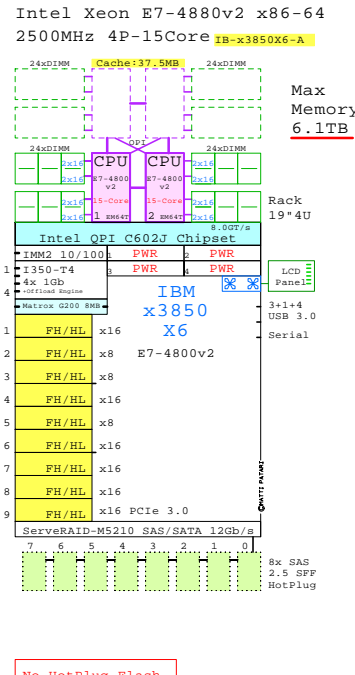

<http://www.goldeneggs.fi/documents/GE-IBM-X3850X6-A.pdf>

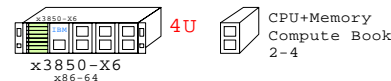

-4x Compute Books for CPU + Memory
-8x Drives, 2.5"
-Expandable to 8P

FUJITSU

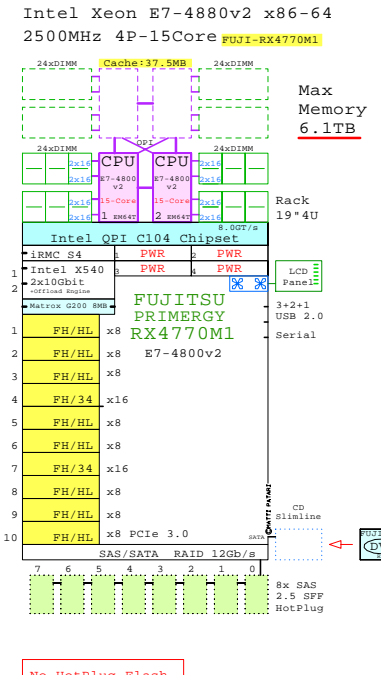

<http://www.goldeneggs.fi/documents/GE-FUJI-RX4770M1-A.pdf>

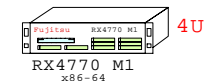

-4x CPU and Memory on Motherboard
-8xDrives, 2.5"

Golden Eggs Home:
<http://www.goldeneggs.fi>

© 2014 Matti Patari, All rights reserved.

GOLDEN EGGS Visuals™ Helsinki	18-Jun-2014	GE-COMP-E74800V2-A
		Matti.Patari@Kolumbus.fi

Compare Rack 4P/4U E7-4800v2 2.5G GOLDEN EGGS Visuals, Helsinki

Made by:
Matti.Patari@Kolumbus.FI

Compare Intel Xeon E7-4800v2 4P/4U rack servers

18-Jun-2014

DELL PE R920
Xeon E7-4880v2

Internal Options:

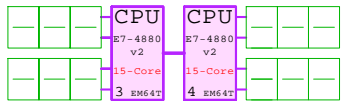

3-4 15-Core
E7-4880v2 37.5MB
2500MHz 130W

- DELL-2M16GB
DIMM Pairs
- DELL-2M32GB
- DELL-2M64GB

- DELL-600GB
600GB 10k SAS 2.5"
- DELL-900GB
900GB 10k SAS 2.5"
- DELL-500GB
500GB SSD SAS 2.5"

- DELL-800GB
800GB Flash SSD 2.5"
- DELL-1.6TB
1.6TB Flash SSD 2.5"

- DELL-DVD
SATA CD-RW/DVD

- DELL-H710P
PERC SAS Raid
- DELL-1GbE
Dell GigabitE 2ch
- DELL-10GE
Qlogic 10Gb CNA 2ch
- DELL-FC2
Emulex FC 8Gb 2ch

Tip for detail printing:
- Zoom in area of interest
- Print, Print CurrentView

Example Configuration
x86-64

Intel Xeon E7-4880v2 x86-64
2500MHz 4P-15Core **DELL-R920-Axx**

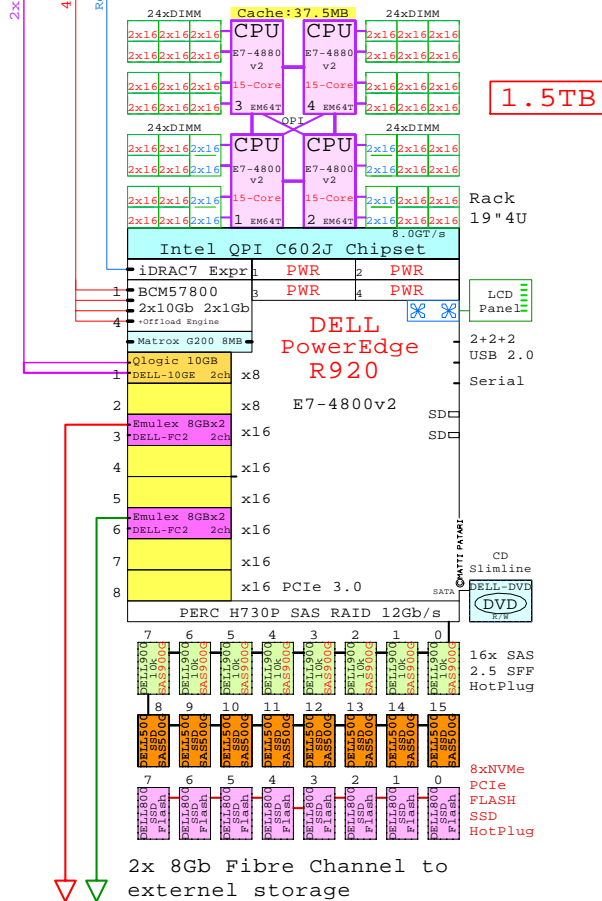

Parts list of the 4P 15-Core 1.5TB Dell R920

Part Number	Qty	Description
DELL-10GE	1	DELL Qlogic 10Gb CNA 2-ch adapter
DELL-2M16GB	40	DELL 2x16GB R920 DIMM Memory Pairs
DELL-500GB	8	Dell 500GB SATA SSD hot-plug disk 2.5"
DELL-800GB	8	Dell 800GB PCIe Flash SSD 2.5" hot-plug
DELL-900GB	8	DELL 900GB SAS 10000r hot-plug disk 2.5"
DELL-DVD	1	DELL CD-RW/DVD-ROM Option kit, slimline
DELL-E74880	1	DELL Xeon 2x E7-4880v2 15-Core 2.5GHz 37
DELL-FC2	2	DELL Emulex FC 8Gb 2-ch PCIe HBA
DELL-R920-A	1	DELL R920 2P 15-C E7-4880v2 37.5MB 256GB

DELL PE R920 Intel E7-4880v2 4P/4U

3-4
Processor +
Memory cartridges

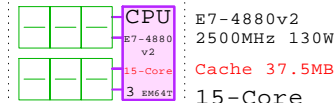

12+12 DIMM
48x DIMM Pairs (2x16, 2x32, 2x64)
iDRAC7 RJ-45 10/100
Network Controllers

- i350-T4
4x 1GigE
- BCM57810S
2x 10GigE

Matrox G200 256MB

8x PCIe 3.0 slots

Storage SAS RAID based 2.5" HotPlug
HDD and SSD, 300GB...900GB

Storage PCIe based 2.5" HotPlug
Flash SSD, 400GB...1.6TB

PCIe-Flash-SSD

GE-link to this document: <http://www.goldeneggs.fi/documents/GE-DELL-R920-A.pdf>

E7-4800v2
2500MHz 15-Core

Intel Xeon E7-4880v2 x86-64
2500MHz 4P-15Core **DELL-R920-Axx**

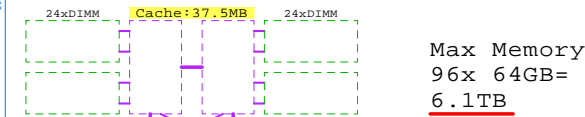

Max Memory
96x 64GB=
6.1TB

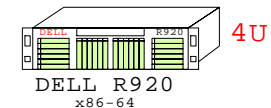
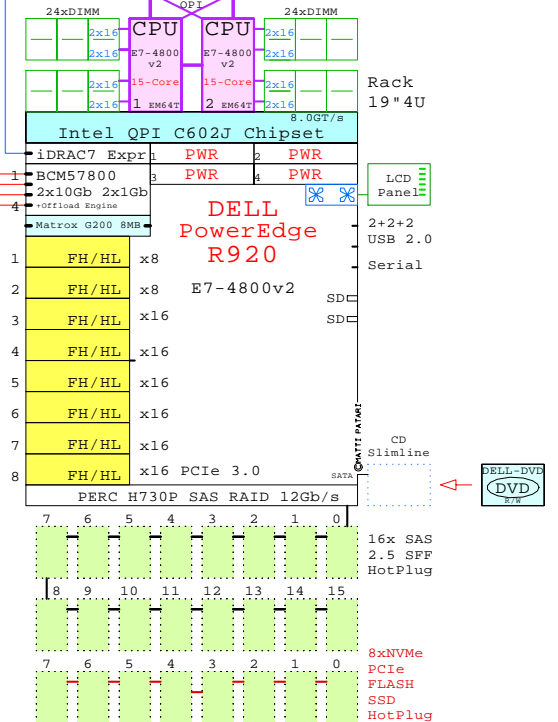

Golden Eggs Home:
<http://www.goldeneggs.fi>

© 2014 Matti Patari, All rights reserved.

GOLDEN EGGS Visuals™ Helsinki	05-Apr-2014	GE-DELL-R920-A Matti.Patari@Kolumbus.fi
-------------------------------	-------------	--

DELL PE R920 4P/4U E7-4880v2 2.5G
GOLDEN EGGS Visuals, Helsinki

HP DL580 Gen8
Xeon E7-4880v2

Internal Options:

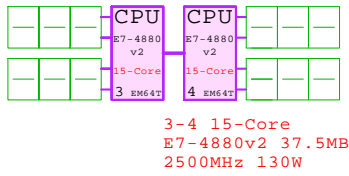

- 2x16 HP-2M16GB DIMM Pairs
- 2x32 HP-2M32GB
- 2x64 HP-2M64GB
- 300GB 15k SAS HDD-300GB 300GB 15k SAS 2.5"
- 600GB 10k SAS HDD-600GB 600GB 10k SAS 2.5"
- 900GB 10k SAS HDD-900GB 900GB 10k SAS 2.5"
- 200GB 8k SAS SSD-200GB 200GB SSD SAS 2.5"
- DVD-USB USB CD-RW/DVD External

- RAID SAS HBA 8-ch PCI PCI-RAID SAS RAID PCIe
- Ethernet 1GbE HBA 2-ch PCI PCI-1GbE Ethernet 2ch
- FC 8Gb HBA 2-ch PCI PCI-FC8 FibreChannel 8Gb 2-ch
- InfiniBand 40 GbE HBA 1-ch PCI PCI-INF40 InfiniBand 1-ch 40Gbs

Tip for detail printing:
- Zoom in area of interest
- Print, Print CurrentView

Example Configuration
x86-64

Intel Xeon E7-4880v2 x86-64
2500MHz 4P-15Core HP-DL580G8-A

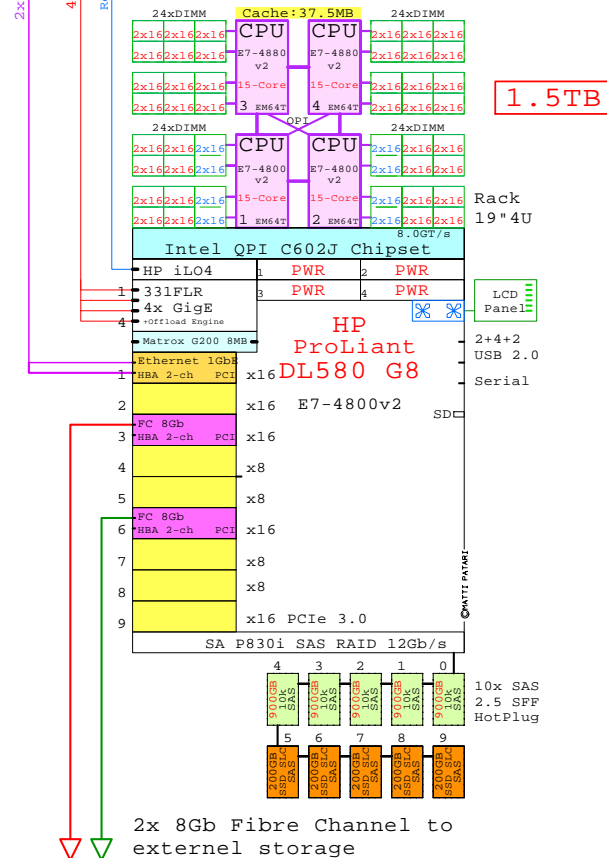

Parts list of the 4P 15-Core 1.5TB HP DL580

Part Number	Qty	Description
HDD-900GB	5	Disk HDD 900GB 2.5" SAS 10k hot-plug
HP-2M16GB	40	HP 2x16GB DL580G8 DIMM Memory Pair
HP-DL580G8-	1	HP DL580G8 2P 15-C E7-4880v2 37.5MB 256G
HP-E74880v2	1	HP Xeon 2x E7-4880v2 15-Core 2.5GHz 37MB
PCI-1GbE	1	Ethernet 2x 1GbE PCI HBA
PCI-FC8	2	Fibre Channel 8Gb 2-ch PCI HBA
SSD-200GB	5	Disk SSD 200GB 2.5" SAS SLC hot-plug

HP DL580 Gen8 Intel E7-4880v2 4P/4U

3-4
Processor+Memory
Plug in Drawer

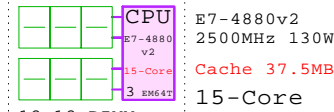

48x DIMM Pairs 2x16 2x32 2x64
HP iLO4 RJ-45 10/100
Network Controllers



Matrox G200 256MB

9x PCIe 3.0 slots

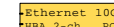

Storage SAS RAID based 2.5" HotPlug
HDD and SSD, 300GB...900GB

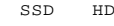

GE-link to this document: <http://www.goldeneggs.fi/documents/GE-HP-DL580G8-A.pdf>

E7-4800v2
2500MHz 15-Core

Intel Xeon E7-4880v2 x86-64
2500MHz 4P-15Core HP-DL580G8-A

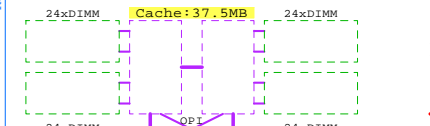

Max Memory
96x 64GB=
6.1TB

48x DIMM Pairs 2x16 2x32 2x64
HP iLO4 RJ-45 10/100
Network Controllers

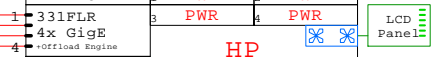

Matrox G200 256MB

9x PCIe 3.0 slots



Storage SAS RAID based 2.5" HotPlug
HDD and SSD, 300GB...900GB

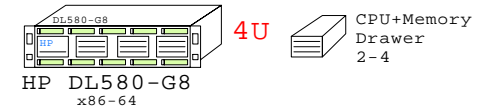
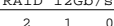

Golden Eggs Home:
<http://www.goldeneggs.fi>

© 2014 Matti Patari, All rights reserved.

GOLDEN EGGS Visuals™ Helsinki	05-Apr-2014	GE-HP-DL580G8-A
		Matti.Patari@Kolumbus.fi

HP DL580 G8 4P/4U E7-4880v2 2.5GH
GOLDEN EGGS Visuals, Helsinki

IBM x3850-X6
Xeon E7-4880v2

Internal Options:

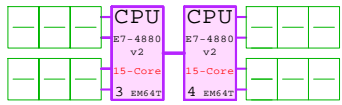

3-4 15-Core
E7-4880v2 37.5MB
2500MHz 130W

- IBM-2M16GB DIMM Pairs
- IBM-2M32GB DIMM Pairs
- IBM-2M64GB DIMM Pairs
- IBM-200GB DDR3 Storage DIMM
- IBM-400GB DDR3 Storage DIMM

HDD-300GB 300GB 15k SAS 2.5"

HDD-600GB 600GB 10k SAS 2.5"

HDD-900GB 900GB 10k SAS 2.5"

SSD-200GB 200GB SSD SAS 2.5"

DVD-USB USB CD-RW/DVD External

PCI-RAID RAID SAS HBA 8-ch PCI SAS RAID PCIe

PCI-1GbE Ethernet 1GbE HBA 2-ch PCI Ethernet 2ch

PCI-FC8 FC 8Gb HBA 2-ch PCI FibreChannel 8Gb 2-ch

PCI-INF40 InfiniBand 40 InfiniBand 1-ch 40Gbps

Example Configuration
x86-64

Intel Xeon E7-4880v2 x86-64
2500MHz 4P-15Core **IB-x3850X6-A**

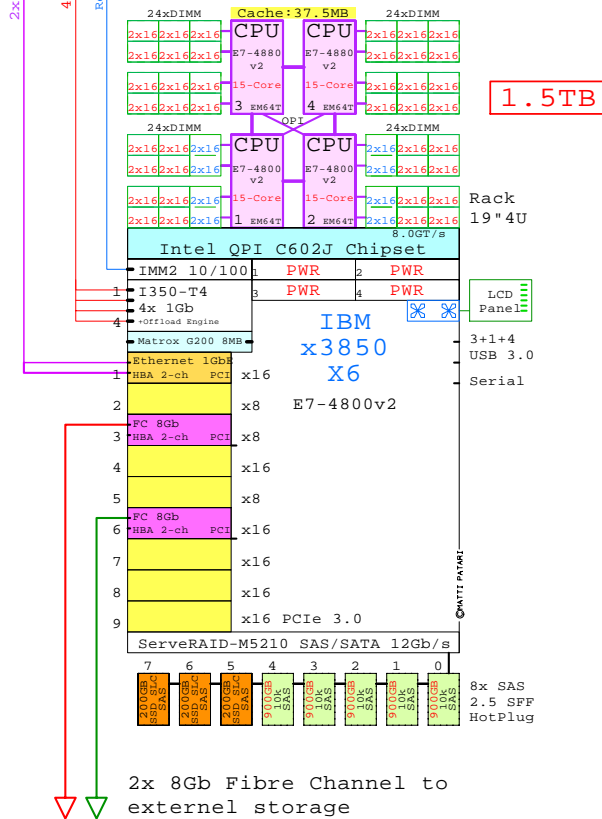

1.5TB

2x 8Gb Fibre Channel to external storage

3-4 Processor+Memory Compute Book

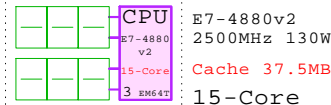

3-4 15-Core
E7-4880v2 37.5MB
2500MHz 130W

48x DIMM Pairs
IBM IMM2 RJ-45 10/100

Network Controllers

1 IX540-ML2 2x 10GbE
1 BCM57810S 2x 10GbE

Matrox G200 256MB

9x PCIe 3.0 slots

Storage SAS RAID based 2.5" HotPlug HDD and SSD, 300GB...900GB

SSD HDD

E7-4800v2
2500MHz 15-Core

Intel Xeon E7-4880v2 x86-64
2500MHz 4P-15Core **IB-x3850X6-A**

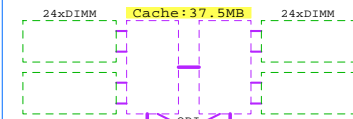

4 15-Core
E7-4880v2 37.5MB
2500MHz 130W

48x DIMM Pairs
IBM IMM2 RJ-45 10/100

Network Controllers

1 IX540-ML2 2x 10GbE
1 BCM57810S 2x 10GbE

Matrox G200 256MB

9x PCIe 3.0 slots

Storage SAS RAID based 2.5" HotPlug HDD and SSD, 300GB...900GB

SSD HDD

Max Memory
96x 64GB=
6.1TB

GE-link to this document: <http://www.goldeneggs.fi/documents/GE-IBM-X3850X6-A.pdf>

Parts list for 4P 15-Core 1.5TB IBM x3850X6

Part Number	Qty	Description
HDD-900GB	5	Disk HDD 900GB 2.5" SAS 10k hot-plug
IB-X3850X6-	1	IBM x3850 X6 2P 15-C E7-4880v2 37.5MB 25
IBM-2M16GB	40	IBM 2x16GB x3850-X6 DIMM Memory pair
IBM-E74880v	1	IBM Xeon 2x E7-4880v2 15-Core 2.5GHz 37M
PCI-1GbE	1	Ethernet 2x 1GbE PCI HBA
PCI-FC8	2	Fibre Channel 8Gb 2-ch PCI HBA
SSD-200GB	3	Disk SSD 200GB 2.5" SAS SLC hot-plug

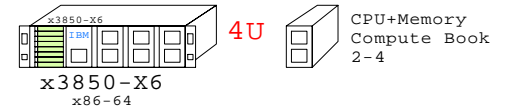

Golden Eggs Home:
<http://www.goldeneggs.fi>

© 2014 Matti Patari, All rights reserved.

GOLDEN EGGS Visuals™ Helsinki	05-Apr-2014	GE-IBM-X3850X6-A
		Matti.Patari@Kolumbus.fi

IBM x3850-X6 E7-4880v2 2.5GHz
GOLDEN EGGS Visuals, Helsinki

Tip for detail printing:
- Zoom in area of interest
- Print, Print CurrentView

IBM x3850-X6 Intel E7-4880v2 4P/4U

FUJITSU RX4770 M1
Xeon E7-4880v2

Internal Options:

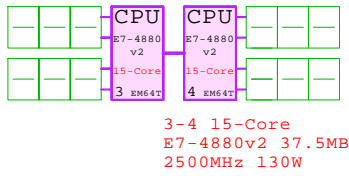

- 2x16 DIMM Pairs
- FUJI-2M16GB
- 2x32 DIMM Pairs
- FUJI-2M32GB
- 2x64 DIMM Pairs
- FUJI-2M64GB
- 300GB 15k SAS HDD-300GB
- 600GB 10k SAS HDD-600GB
- 900GB 10k SAS HDD-900GB
- 200GB 8k SAS SSD-200GB
- FUJI-DVD

- RAID SAS HBA 8-ch PCI
- PCI-RAID SAS RAID PCIe
- Ethernet 10Gb HBA 2-ch PCI
- PCI-1GbE Ethernet 2ch
- FC 8Gb HBA 2-ch PCI
- PCI-FC8 FibreChannel 8Gb 2-ch
- InfiniBand 40 HBA 1-ch PCI
- PCI-INF40 InfiniBand 1-ch 40Gbs

Example Configuration
x86-64

Intel Xeon E7-4880v2 x86-64
2500MHz 4P-15Core FUJI-RX4770M1

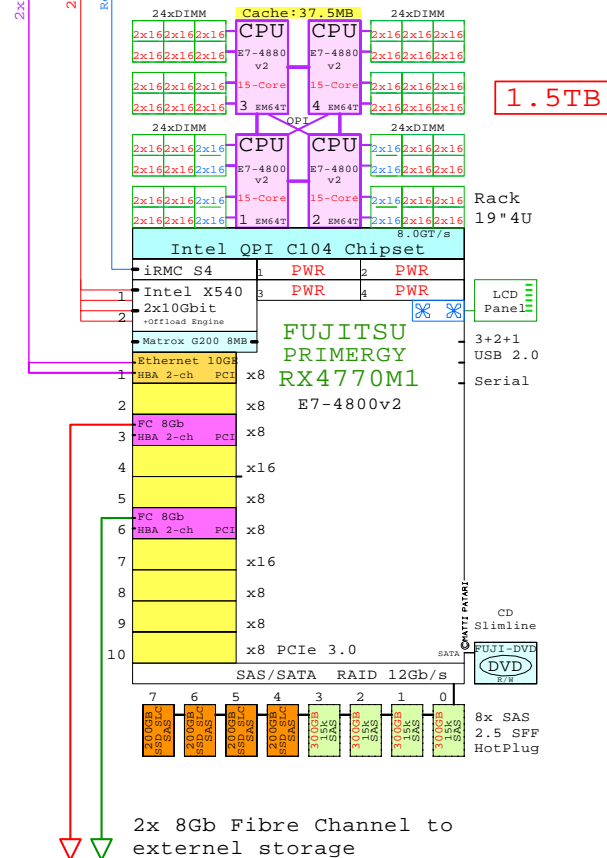

2x 8Gb Fibre Channel to external storage

3-4 Processor+Memory Plug in

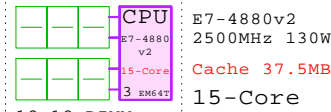

48x DIMM Pairs 2x16 2x32 2x64
Fuji iRM S5 RJ-45 10/100/1000
Network Controllers

Matrox G200 256MB

10x PCIe 3.0 slots

Storage SAS RAID based 2.5" HotPlug HDD and SSD, 300GB...900GB

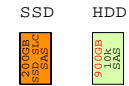

E7-4800v2
2500MHz 15-Core

Intel Xeon E7-4880v2 x86-64
2500MHz 4P-15Core FUJI-RX4770M1

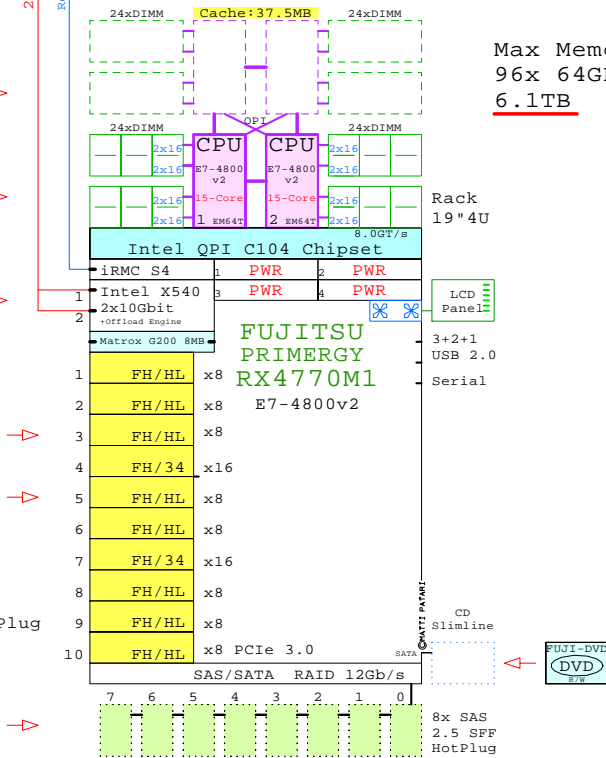

Max Memory
96x 64GB=
6.1TB

GE-link to this document: <http://www.goldeneggs.fi/documents/GE-FUJI-RX4770M1-A.pdf>

Parts list of the 4P 15-Core 1.5TB RX4770-M1

Part Number	Qty	Description
FU-RX4770-M	1	Fuji RX4770-M1 2P 15-C E7-4880v2 37.5MB
FUJI-2M16GB	40	Fuji 2x16GB RX4770-M1 DIMM Memory
FUJI-DVD	1	FUJI CD-RW/DVD-ROM Option kit, slimline
FUJI-E74880	1	Fuji Xeon 2x E7-4880v2 15-Core 2.5GHz 37
HDD-300GB	4	Disk HDD 300GB 2.5" SAS 15k hot-plug
PCI-10GbE	1	Ethernet 2x 10GbE PCI HBA
PCI-FC8	2	Fibre Channel 8Gb 2-ch PCI HBA
SSD-200GB	4	Disk SSD 200GB 2.5" SAS SLC hot-plug

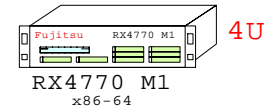

Golden Eggs Home:
<http://www.goldeneggs.fi>

© 2014 Matti Patari, All rights reserved.

GOLDEN EGGS Visuals™ Helsinki	17-Jun-2014	GE-FUJI-RX4770M1-A Matti.Patari@Kolumbus.fi
-------------------------------	-------------	--

FUJI RX4770-M1 4P E7-4880v2 2.5GH
GOLDEN EGGS Visuals, Helsinki

Tip for detail printing:
- Zoom in area of interest
- Print, Print CurrentView

FUJITSU RX4770-M1 Intel E7-4880v2 4P/4U

SUPERMICRO 4048-B
Xeon E7-4880v2

Internal Options:

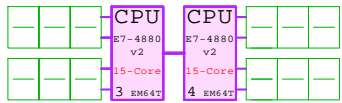

3-4 15-Core
 E7-4880v2 37.5MB
 2500MHz 130W

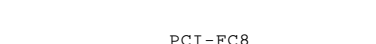
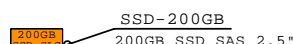
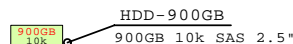
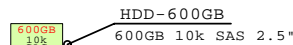
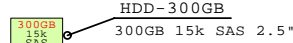
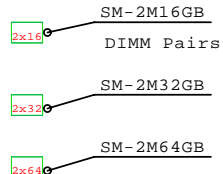

Tip for detail printing:
 - Zoom in area of interest
 - Print, Update Current View

Example Configuration
x86-64

Intel Xeon E7-4880v2 x86-64
 2500MHz 4P-15Core **SM4048B-Axx**

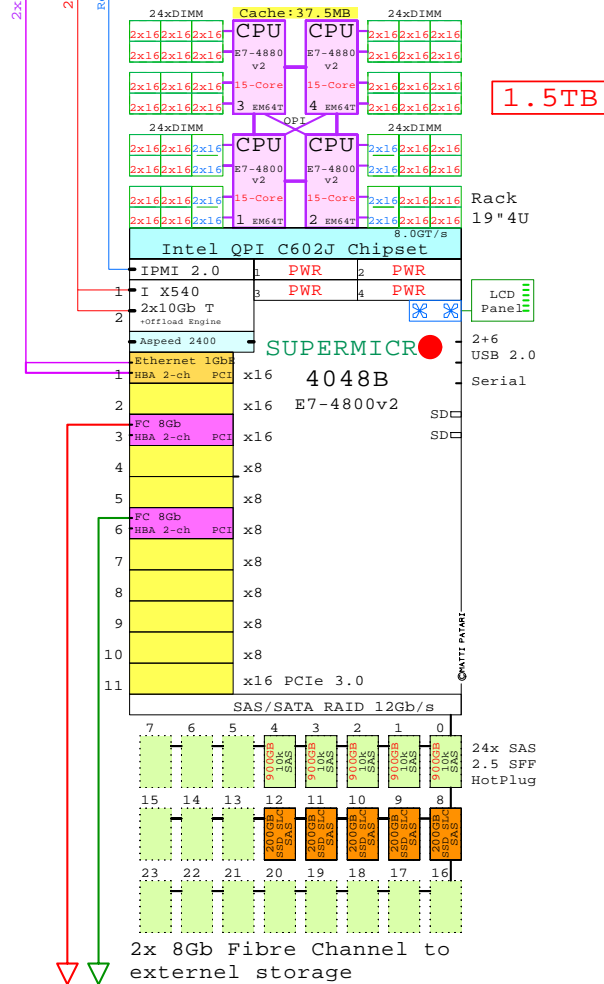

Parts list of the 4P 15-Core 1.5TB SM 4048-B

Part Number	Qty	Description
HDD-900GB	5	Disk HDD 900GB 2.5" SAS 10k hot-plug
SM-2M16GB	40	SM 2x16GB 4048-B DIMM Memory Pair
SM-4048-B	1	SM 4048-B 2P 15-C E7-4880v2 37.5MB 256G
SM-E74880v2	1	SM Xeon 2x E7-4880v2 15-Core 2.5GHz 37MB
PCI-1GbE	1	Ethernet 2x 1GbE PCI HBA
PCI-FC8	2	Fibre Channel 8Gb 2-ch PCI HBA
SSD-200GB	5	Disk SSD 200GB 2.5" SAS SLC hot-plug

SUPERMICRO 4048-B Intel E7-4880v2 4P/4U

E7-4800v2
2500MHz 15-Core

Intel Xeon E7-4880v2 x86-64
 2500MHz 4P-15Core **SM4048B-Axx**

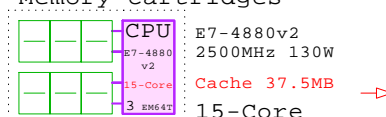

3-4
 Processor +
 Memory cartridges
 E7-4880v2
 2500MHz 130W
 Cache 37.5MB
 15-Core

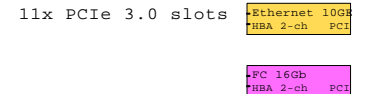
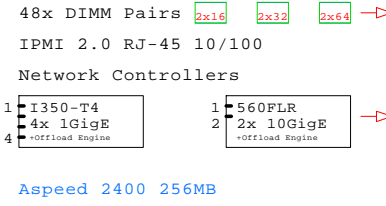

Storage SAS RAID based 2.5" HotPlug
 HDD and SSD, 300GB...900GB

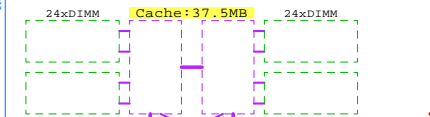
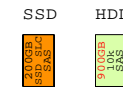

Max Memory
 96x 64GB=
6.1TB

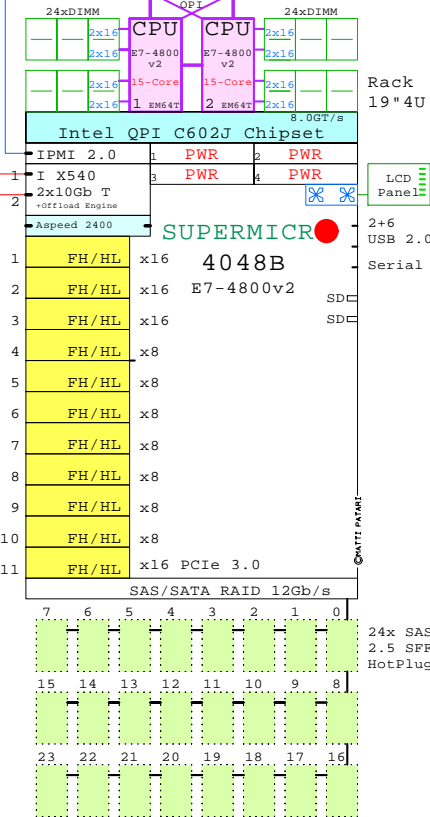

GE-link to this document: <http://www.goldeneggs.fi/documents/GE-SM-4048B-A.pdf>

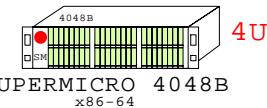

Golden Eggs Home:
<http://www.goldeneggs.fi>

© 2014 Matti Patari, All rights reserved.

GOLDEN EGGS Visuals™ Helsinki	14-Apr-2014	GE-SM-4048B-A
	Matti.Patari@Kolumbus.fi	

SUPERMICRO 4048-B E7-4880v2 2.5GH
 GOLDEN EGGS Visuals, Helsinki

Welcome to GoldenEggs x86 Visual Configurations

<http://www.goldeneggs.fi>

A picture is worth of one thousand words.
It talks all Global languages.

x86-64 servers: **Dell** **IBM** **HP** **Fujitsu** **SUN** **Acer** **Lenovo** and **Cisco**

4x Gigabit E iDRAC7 Remote Manager

Intel Xeon E5-2680 x86-64
2700MHz 2P 8-Core **DELL-R720-A**

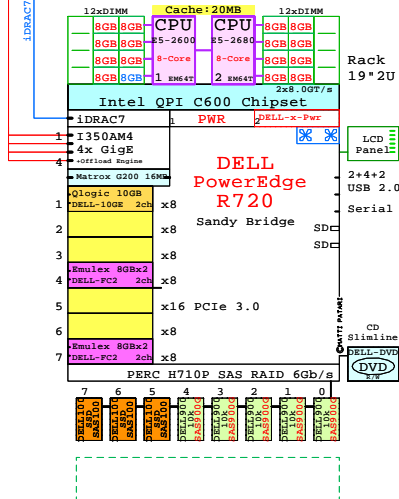

Intel Xeon E5-2680 x86-64
2700MHz 2P 8-Core **IBM-7914-L2x**

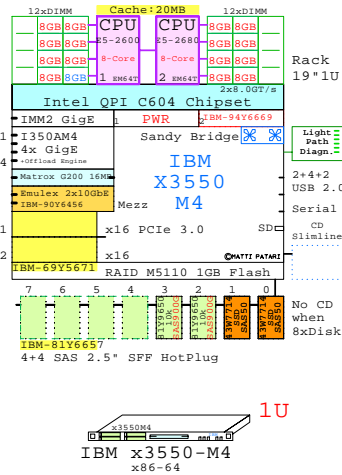

AMD Opteron 6172 x86-64
2100MHz 2P 12-Core **573088-421 EU**

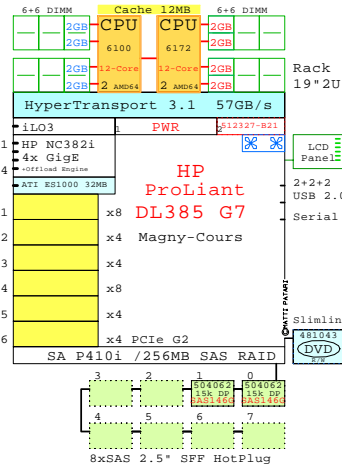

Dell Blades

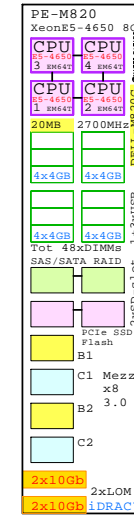

Fujitsu

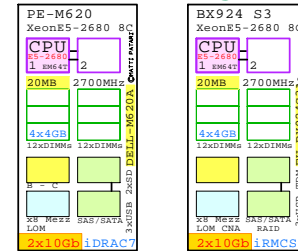

HP Blades

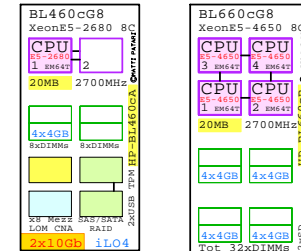

IBM Blades

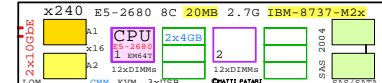

Cisco Blades

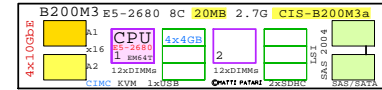

Donate

PayPal at:
www.GoldenEggs.fi

This x86 site is open, vendor independent.
It is fully funded from my own pocket.
To keep this service running,
Your personal support is welcome.

Matti.Patari@Kolumbus.fi
Helsinki Finland

Older GoldenEggs sites:

<http://h18000.www1.hp.com/info/GECPQA/>

<http://www.openvms.org/pages.php?page=GoldenEggs>

GE-links to x86 COMPARE Pictures:

New <http://www.goldeneggs.fi/documents/GE-COMPARE-BLADE-A.pdf>

<http://www.goldeneggs.fi/documents/GE-INT-E5-MAP-A.pdf>

<http://www.goldeneggs.fi/documents/GE-COMP-E52400-A.pdf>

<http://www.goldeneggs.fi/documents/GE-COMP-E52600-A.pdf>

<http://www.goldeneggs.fi/documents/GE-COMP-E54600-A.pdf>

New <http://www.goldeneggs.fi/documents/GE-COMP-E74800V2-A.pdf>

GE-link to GE 25 Year-Book

New <http://www.goldeneggs.fi/documents/GE-25-YEAR-BOOK.pdf>

Follow GoldenEggs on Twitter:

@goldeneggsfi

©2014 Matti Patari, All rights reserved.

GOLDEN EGGS Visuals™ Helsinki	21-Mar-2014	GE-Welcome1
		Matti.Patari@Kolumbus.Fi

Welcome to Visual Configurations
GOLDEN EGGS Visuals, Helsinki

GE-Welcome1