

Compare Intel Xeon E7-8800v3 4-socket 4U x86 rack servers

GE-link to this document: <http://www.goldeneggs.fi/documents/GE-COMP-E78800V3-A.pdf>

Haswell-EX
2500MHz 18-Core

3-4 processor
2500MHz 165W
Cache 45MB

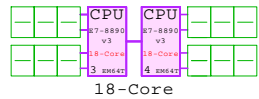

48x DIMM Pairs

iDRAC8 RJ-45 10/100/1000
4x RJ-45 10Gb and 1Gb

Matrox G200 8MB

8x PCIe 3.0 slots

Storage SAS RAID based 2.5" HotPlug
HDD and SSD, 300GB...900GB



Storage PCIe based 2.5" HotPlug
Flash SSD, 400GB...1.6TB

PCIe-Flash-SSD

DELL

Intel Xeon E7-8890v3 x86-64
2500MHz 4P-18Core **DELL-R930-A**

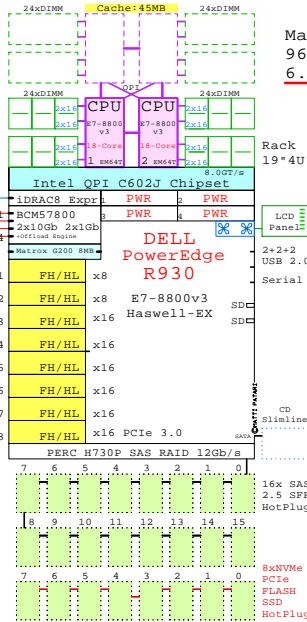

Max Memory
96x 64GB=
6.1TB

HP

Intel Xeon E7-8890v3 x86-64
2500MHz 4P-18Core **HP-DL580G9-A**

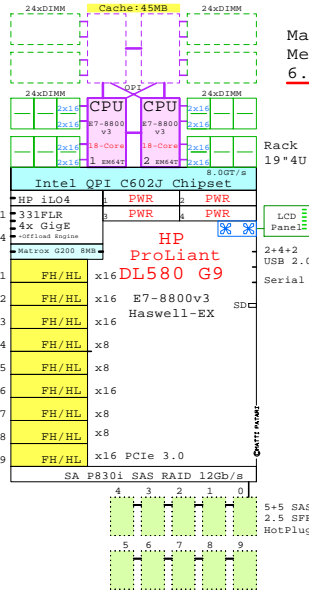

Max Memory
6.1TB

Lenovo

Intel Xeon E7-8890v3 x86-64
2500MHz 4P-18Core **LEN-x3850X6-A**

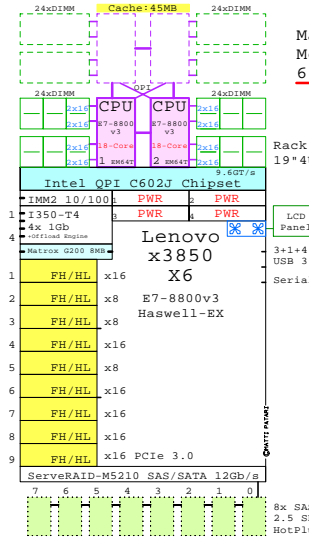

Max Memory
6.1TB

FUJITSU

Intel Xeon E7-8890v3 x86-64
2500MHz 4P-18Core **FUJI-RX4770M2**

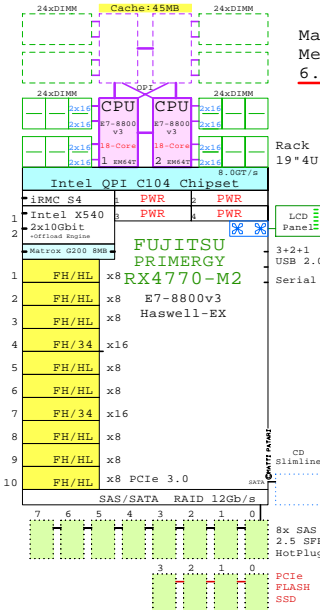

Max Memory
6.1TB

<http://www.goldeneggs.fi/documents/GE-DELL-R930-A.pdf>

Link to the detailed R930 GE-document.

<http://www.goldeneggs.fi/documents/GE-HP-DL580G9-A.pdf>

<http://www.goldeneggs.fi/documents/GE-LENOVO-X3850X6-A.pdf>

<http://www.goldeneggs.fi/documents/GE-FUJI-RX4770M2-A.pdf>

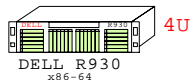

-4x CPU and Memory on Motherboard
-24xDrives, 2.5"

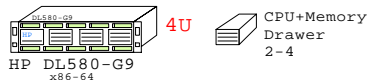

-4x Compute Drawers for CPU + Memory
-10xDrives, 2.5"

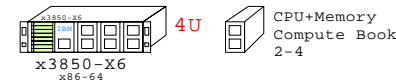

-4x Compute Books for CPU + Memory
-8x Drives, 2.5"
-Expandable to 8P

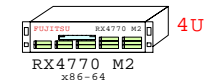

-4x CPU and Memory on Motherboard
-8xDrives, 2.5"

Golden Eggs Home:
<http://www.goldeneggs.fi>

© 2015 Matti Patari, All rights reserved.

GOLDEN EGGS Visuals Helsinki	12-May-2015 Matti.Patari@Kolumbus.fi	GE-COMP-E78800V3-A
------------------------------------	---	--------------------

Compare Rack 4P/4U E7-8800v3 2.5G
GOLDEN EGGS Visuals, Helsinki

Made by:
Matti.Patari@Kolumbus.FI

Compare Intel Xeon E7-8800v3 4P/4U rack servers

12-May-2015

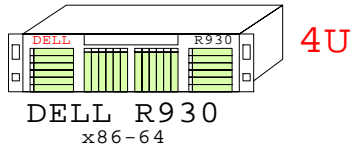

3-4
Processor+Memory
Plug in

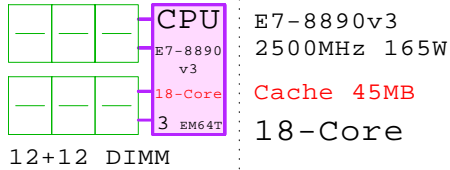

48x DIMM Pairs 2x16 2x32 2x64

iDRAC8 RJ-45 10/100

4x RJ-45 10Gb and 1Gb

Matrox G200 256MB

8x PCIe 3.0 slots
Qlogic 10GB
DELL-10GE 2ch

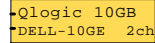

Emulex 8Gb x2
DELL-FC2 2ch

Storage SAS RAID based 2.5" HotPlug
HDD and SSD, 300GB...900GB

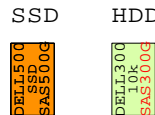

Storage PCIe based 2.5" HotPlug
Flash SSD, 400GB...1.6TB

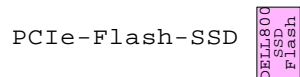

4x Gigabit E Remote Manager

E7-8890v3
2500MHz 18-Core

Intel Xeon E7-8890v3 x86-64
2500MHz 4P-18Core DELL-R930-A

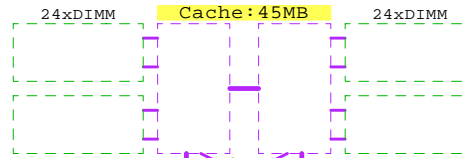

Max Memory
96x 64GB=
6.1TB

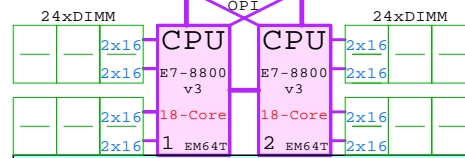

Rack
19" 4U

8.0GT/s
Intel QPI C602J Chipset

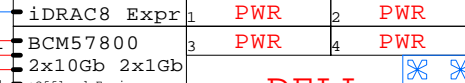

DELL
PowerEdge
R930

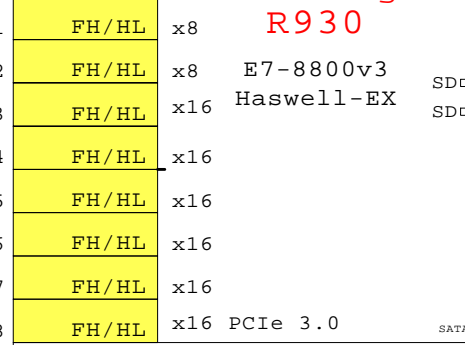

2+2+2
USB 2.0
Serial

CD Slimline

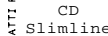

PERC H730P SAS RAID 12Gb/s

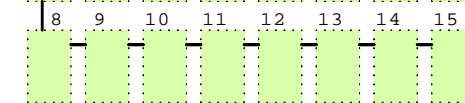
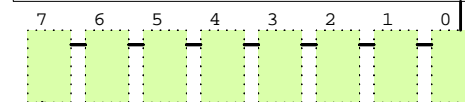

8xNVMe
PCIe
FLASH
SSD
HotPlug

DELL PE R930
Xeon E7-8890v3

Internal Options:

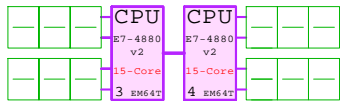

- DELL-2M16GB
DIMM Pairs
- DELL-2M32GB
- DELL-2M64GB

- DELL-600GB
600GB 10k SAS 2.5"
- DELL-900GB
900GB 10k SAS 2.5"
- DELL-500GB
500GB SSD SAS 2.5"

- DELL-800GB
800GB Flash SSD 2.5"
- DELL-1.6TB
1.6TB Flash SSD 2.5"

- DELL-DVD
SATA CD-RW/DVD

- DELL-H710P
PERC SAS Raid
- DELL-1GbE
Dell GigabitE 2ch
- DELL-10GE
Qlogic 10Gb CNA 2ch
- DELL-FC2
Emulex FC 8Gb 2ch

Tip for detail printing:
- Zoom in area of interest
- Print, Print Current View

Example Configuration
x86-64

Intel Xeon E7-8890v3 x86-64
2500MHz 4P-18Core **DELL-R930-A**

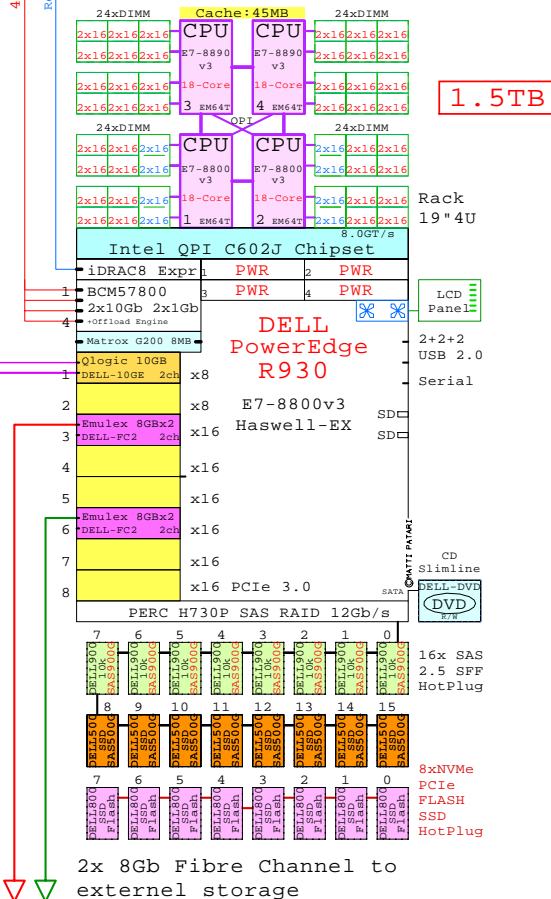

Parts list of the 4P 15-Core 1.5TB Dell R930

Part Number	Qty	Description
DELL-10GE	1	DELL Qlogic 10Gb CNA 2-ch adapter
DELL-2M16GB	40	DELL 2x16GB R920 DIMM Memory
DELL-500GB	8	Dell 500GB SATA SSD hot-plug disk 2.5"
DELL-800GB	8	Dell 800GB PCIe Flash SSD 2.5" hot-plug
DELL-900GB	8	Dell 900GB SAS 10000r hot-plug disk 2.5"
DELL-DVD	1	DELL CD-RW/DVD-ROM Option kit, slimline
DELL-E78890	1	DELL Xeon 2x E7-8890v3 18-Core 2.5GHz 45
DELL-FC2	2	DELL Emulex FC 8Gb 2-ch PCIe HBA
DELL-R930-A	1	DELL R930 2P 18-C E7-8890v3 45MB 256GB 4

DELL PE R930 Intel E7-8890v3 4P/4U

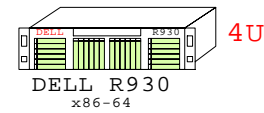

3-4
Processor+Memory
Plug in

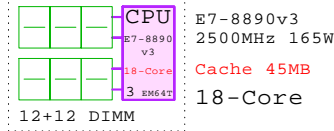

- 48x DIMM Pairs 2x16 2x32 2x64
- iDRAC8 RJ-45 10/100
- 4x RJ-45 10Gb and 1Gb
- Matrox G200 256MB

- 8x PCIe 3.0 slots
- Qlogic 10GB
DELL-10GE 2ch
- Emulex 8GbX2
DELL-FC2 2ch

- Storage SAS RAID based 2.5" HotPlug HDD and SSD, 300GB...900GB
- Storage PCIe based 2.5" HotPlug Flash SSD, 400GB...1.6TB

- PCIe-Flash-SSD

GE-link to this document: <http://www.goldeneggs.fi/documents/GE-DELL-R930-A.pdf>

E7-8890v3
2500MHz 18-Core

Intel Xeon E7-8890v3 x86-64
2500MHz 4P-18Core **DELL-R930-A**

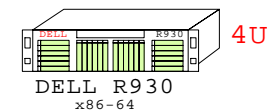
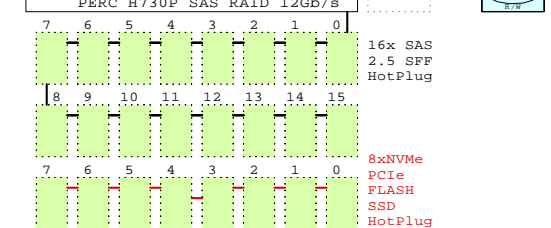
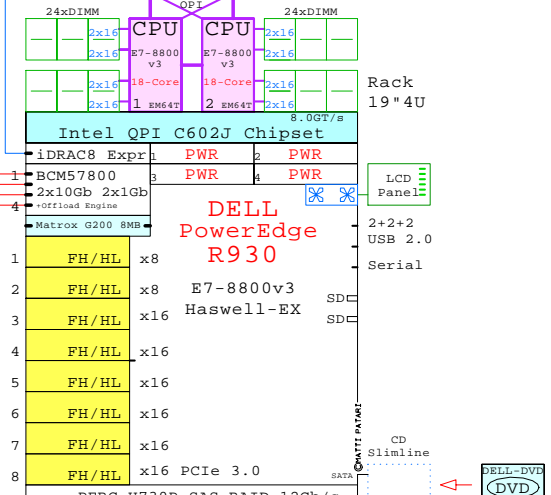
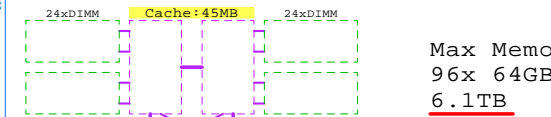

Golden Eggs Home:
<http://www.goldeneggs.fi>

© 2015 Matti Patari, All rights reserved.

GOLDEN EGGS Visuals Helsinki	12-May-2015	GE-DELL-R930-A Matti.Patari@Kolumbus.fi
DELL PE R930 4P/4U E7-8890v3 2.5G		GOLDEN EGGS Visuals, Helsinki

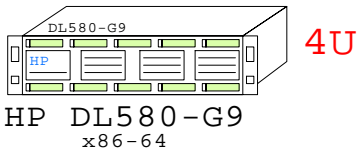

3-4
Processor+Memory
Plug in Drawer

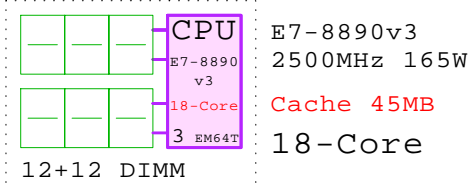

48x DIMM Pairs 2x16 2x32 2x64

HP iLO4 RJ-45 10/100

Network Controllers



Matrox G200 256MB

9x PCIe 3.0 slots

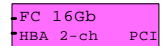
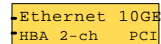

Storage SAS RAID based 2.5" HotPlug
HDD and SSD, 300GB...900GB

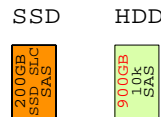

4x Gigabit E Remote Manager

E7-8890v3
2500MHz 18-Core

Intel Xeon E7-8890v3 x86-64
2500MHz 4P-18Core HP-DL580G9-A

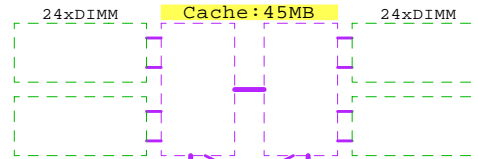

Max Memory
96x 64GB=
6.1TB

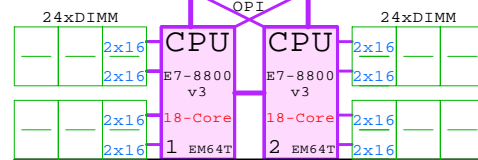

Rack
19" 4U

Intel QPI C602J Chipset 8.0GT/s

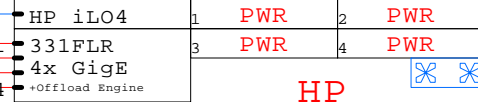

HP ProLiant DL580 G9

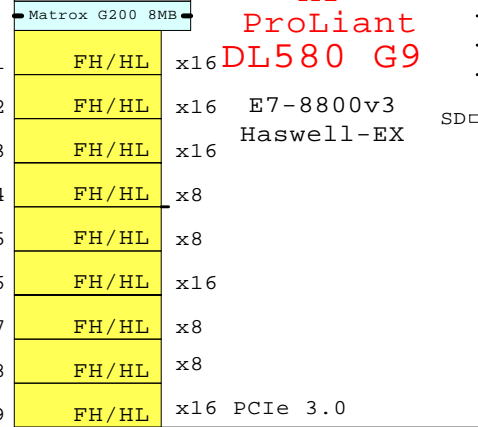

2+4+2
USB 2.0

Serial

SD

SA P830i SAS RAID 12Gb/s

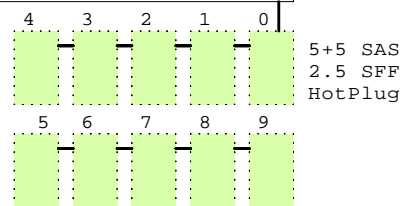

HP DL580 Gen9
Xeon E7-8890v3

Internal Options:

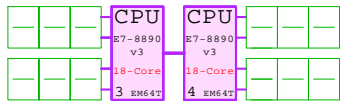

3-4 18-Core
E7-8890v3 45MB
2500MHz 165W

- HP-2M16GB DIMM Pairs
- HP-2M32GB
- HP-2M64GB

HDD-300GB
300GB 15k SAS 2.5"

HDD-600GB
600GB 10k SAS 2.5"

HDD-900GB
900GB 10k SAS 2.5"

SSD-200GB
200GB SSD SAS 2.5"

DVD-USB
USB CD-RW/DVD External

PCI-RAID
RAID SAS HBA 8-ch PCI

PCI-1GbE
Ethernet 1GbE HBA 2-ch PCI

PCI-FC8
FC 8Gb HBA 2-ch PCI

PCI-INF40
InfiniBand 40 HBA 1-ch PCI

Tip for detail printing:
- Zoom in area of interest
- Print, Print Current View

Example Configuration
x86-64

Intel Xeon E7-8890v3 x86-64
2500MHz 4P-18Core HP-DL580G9-A

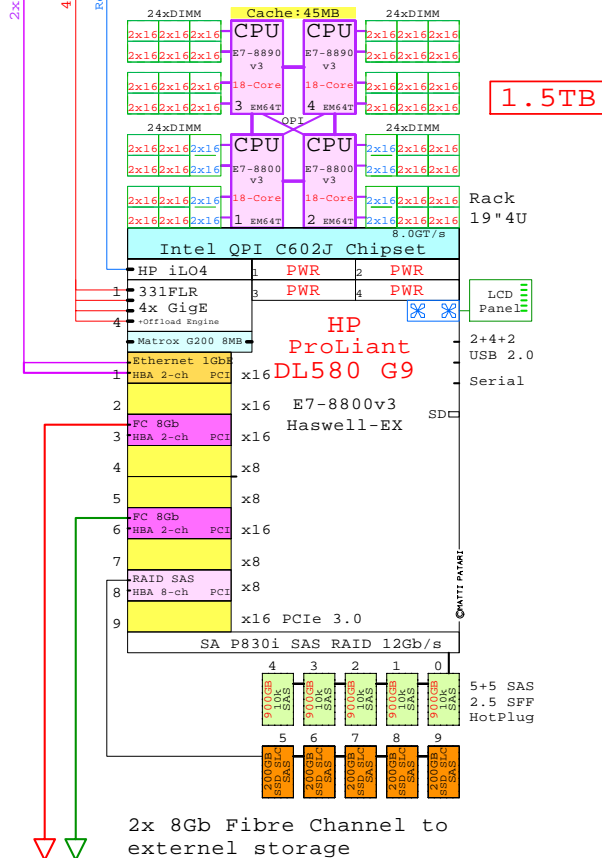

Parts list of the 4P 18-Core 1.5TB HP DL580 G9

Part Number	Qty	Description
HDD-900GB	5	Disk HDD 900GB 2.5" SAS 10k hot-plug
HP-2M16GB	40	HP 2x16GB DL580G8 DIMM Memory Pair
HP-DL580G9-	1	HP DL580G9 2P 18-C E7-8890v3 45MB 256GB
HP-E78890v3	1	HP Xeon 2x E7-8890v3 18-Core 2.5GHz 45MB
PCI-1GbE	1	Ethernet 4x 1GbE PCI HBA
PCI-FC8	2	Fibre Channel 8Gb 2-ch PCI HBA
PCI-RAID	1	Raid SAS PCI HBA 8-ch
SSD-200GB	5	Disk SSD 200GB 2.5" SAS SLC hot-plug

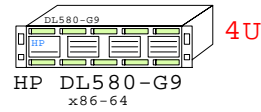

3-4
Processor+Memory
Plug in Drawer

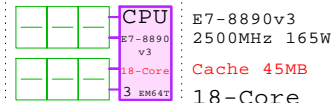

48x DIMM Pairs
HP iLO4 RJ-45 10/100
Network Controllers

534FLR 2x 10GigE
560FLR 2x 10GigE

Matrox G200 256MB

9x PCIe 3.0 slots
Ethernet 10GbE HBA 2-ch PCI
FC 16Gb HBA 2-ch PCI

Storage SAS RAID based 2.5" HotPlug
HDD and SSD, 300GB...900GB

SSD HDD
200GB SSD SAS
900GB SAS

GE-link to this document: <http://www.goldeneggs.fi/documents/GE-HP-DL580G9-A.pdf>

E7-8890v3
2500MHz 18-Core

Intel Xeon E7-8890v3 x86-64
2500MHz 4P-18Core HP-DL580G9-A

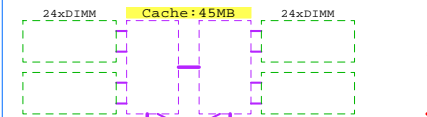

Max Memory
96x 64GB=
6.1TB

48x DIMM Pairs
HP iLO4 RJ-45 10/100
Network Controllers

534FLR 2x 10GigE
560FLR 2x 10GigE

Matrox G200 8MB

9x PCIe 3.0 slots
Ethernet 10GbE HBA 2-ch PCI
FC 16Gb HBA 2-ch PCI

Storage SAS RAID based 2.5" HotPlug
HDD and SSD, 300GB...900GB

SSD HDD
200GB SSD SAS
900GB SAS

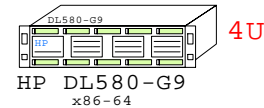

CPU+Memory
Drawer
2-4

Golden Eggs Home:
<http://www.goldeneggs.fi>

© 2015 Matti Patari, All rights reserved.

GOLDEN EGGS Visuals™ Helsinki	11-May-2015	GE-HP-DL580G9-A
		Matti.Patari@Kolumbus.fi

HP DL580 G9 4P/4U E7-8890v3 2.5GHZ
GOLDEN EGGS Visuals, Helsinki

HP DL580 Gen9 Intel E7-8890v3 4P/4U

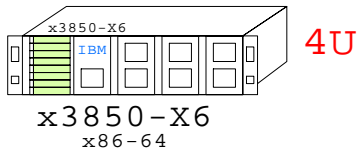

3-4
Processor+Memory
Compute Book

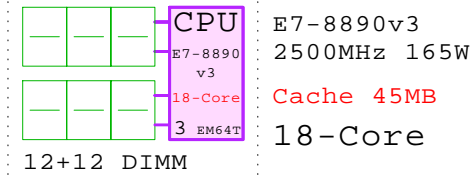

48x DIMM Pairs 2x16 2x32 2x64 →

IBM IMM2 RJ-45 10/100

Network Controllers



Matrox G200 256MB

9x PCIe 3.0 slots

Ethernet 10Gb
HBA 2-ch PCI →

FC 16Gb
HBA 2-ch PCI →

Storage SAS RAID based 2.5" HotPlug
HDD and SSD, 300GB...900GB



4x Gigabit E
Remote Manager

E7-8890v3
2500MHz 18-Core

Intel Xeon E7-8890v3 x86-64
2500MHz 4P-18Core LENOVO-x3850X6-A

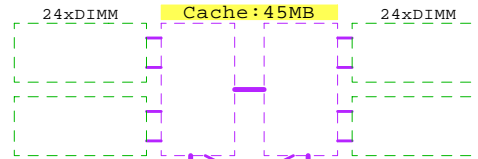

Max Memory
96x 64GB=
6.1TB

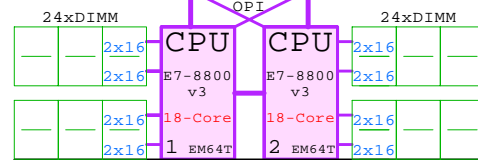

Rack
19" 4U

Intel QPI C602J Chipset 9.6GT/s

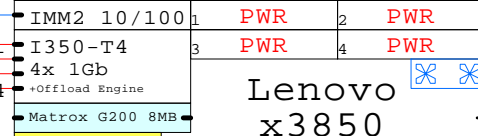

Lenovo
x3850
X6
E7-8800v3
Haswell-EX

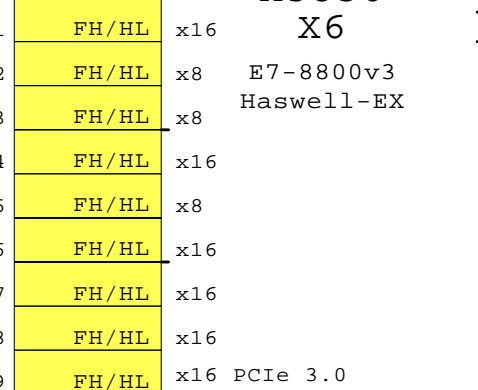

3+1+4
USB 3.0
Serial

ServerRAID-M5210 SAS/SATA 12Gb/s

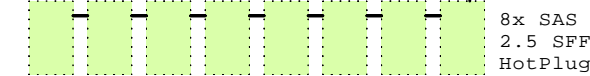

Lenovo x3850-X6
Xeon E7-8890v3

Internal Options:

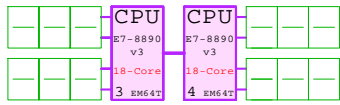

3-4 18-Core
E7-8890v3 45MB
2500MHz 165W

- IBM-2M16GB DIMM Pairs
- IBM-2M32GB DIMM Pairs
- IBM-2M64GB DIMM Pairs
- IBM-200GB DDR3 Storage DIMM
- IBM-400GB DDR3 Storage DIMM

- HDD-300GB 300GB 15k SAS 2.5"
- HDD-600GB 600GB 10k SAS 2.5"
- HDD-900GB 900GB 10k SAS 2.5"
- SSD-200GB 200GB SSD SAS 2.5"
- DVD-USB USB CD-RW/DVD External

- PCI-RAID RAID SAS HBA 8-ch PCI
- PCI-1GbE Ethernet 1GbE HBA 2-ch PCI
- PCI-FC8 FibreChannel 8Gb 2-ch HBA 2-ch PCI
- PCI-INF40 InfiniBand 1-ch 40Gbps HBA 1-ch PCI

Tip for detail printing:
- Zoom in area of interest
- Print, Print Current View

Example Configuration
x86-64

Intel Xeon E7-8890v3 x86-64
2500MHz 4P-18Core LENO-x3850X6-A

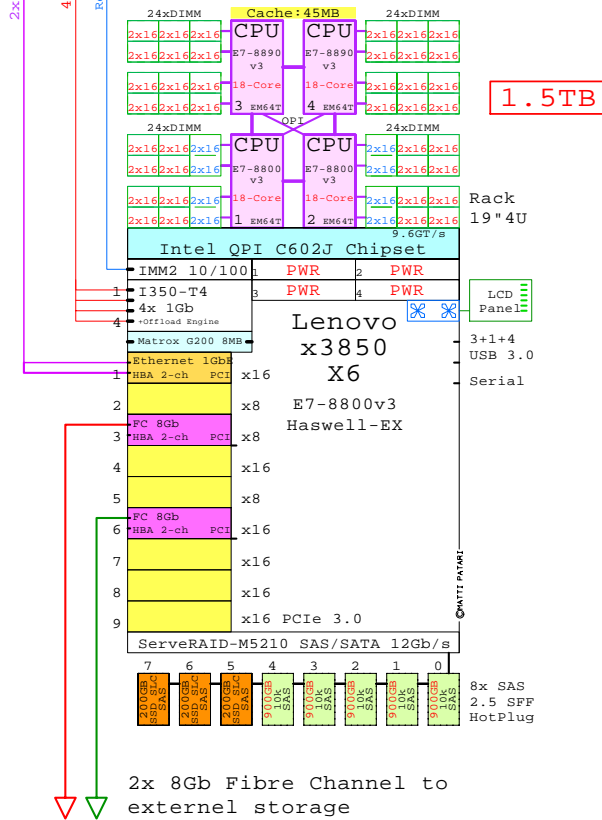

1.5TB

2x 8Gb Fibre Channel to external storage

Parts list for 4P 18-Core 1.5TB Lenovo x3850X6

Part Number	Qty	Description
HDD-900GB	5	Disk HDD 900GB 2.5" SAS 10k hot-plug
IBM-2M16GB	40	IBM 2x16GB x3850-X6 DIMM Memory pair
LEN-E78890v	1	Lenovo Xeon 2x E7-8890v3 18-Core 2.5GHz
LEN-X3850X6	1	Lenovo x3850 X6 2P 18-C E7-8890v3 45MB 2
PCI-1GbE	1	Ethernet 4x 1GbE PCI HBA
PCI-FC8	2	Fibre Channel 8Gb 2-ch PCI HBA
SSD-200GB	3	Disk SSD 200GB 2.5" SAS SLC hot-plug

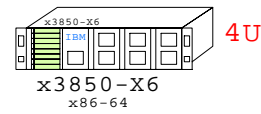

3-4
Processor+Memory
Compute Book

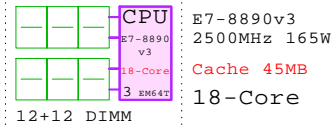

48x DIMM Pairs
IBM IMM2 RJ-45 10/100
Network Controllers



Matrox G200 256MB

9x PCIe 3.0 slots

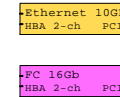

Storage SAS RAID based 2.5" HotPlug
HDD and SSD, 300GB...900GB

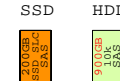

GE-link to this document: <http://www.goldeneggs.fi/documents/GE-LENOVO-X3850X6-A.pdf>

E7-8890v3
2500MHz 18-Core

Intel Xeon E7-8890v3 x86-64
2500MHz 4P-18Core LENO-x3850X6-A

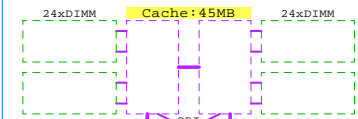

Max Memory
96x 64GB=
6.1TB

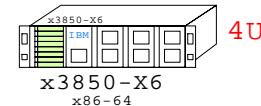
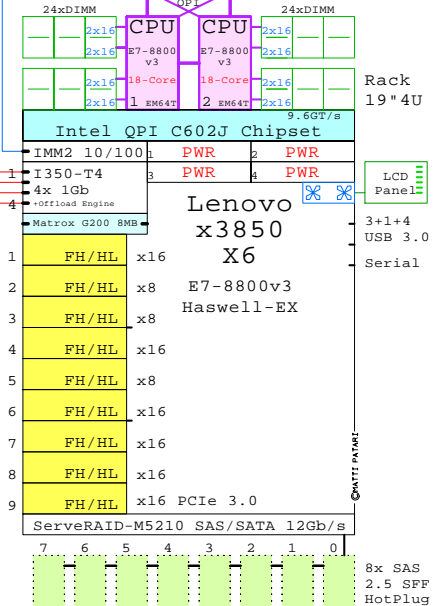

CPU+Memory
Compute Book
2-4

Golden Eggs Home:
<http://www.goldeneggs.fi>

© 2014 Matti Patari, All rights reserved.

GOLDEN EGGS Visuals™ Helsinki	28-Apr-2015	GE-LENOVO-X3850X6A Matti.Patari@Kolumbus.fi
-------------------------------	-------------	--

Lenovo x3850-X6 E7-8890v3 2.5GHz
GOLDEN EGGS Visuals, Helsinki

Lenovo x3850-X6 Intel E7-8890v3 4P/4U

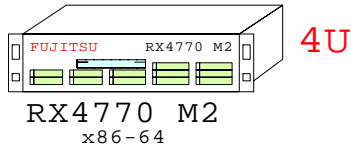

3-4
 Processor+Memory
 Plug in

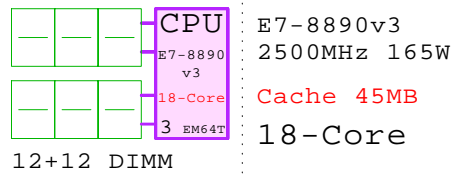

48x DIMM Pairs **2x16** **2x32** **2x64**

Fujitsu iRMC S4 RJ-45 10/100/1000

Matrox G200 256MB

10x PCIe 3.0 slots
 Ethernet 10Gb
 HBA 2-ch PCI
 FC 16Gb
 HBA 2-ch PCI

Storage SAS RAID based 2.5" HotPlug
 HDD and SSD, 300GB...900GB

SSD HDD
 300GB SAS
 900GB SAS
 4x PCIe-Flash-SSD
 1600GB FLA SSD
 PCIe

E7-8800v3
2500MHz 18-Core

Intel Xeon E7-8890v3 x86-64
 2500MHz 4P-18Core **FUJI-RX4770M2**

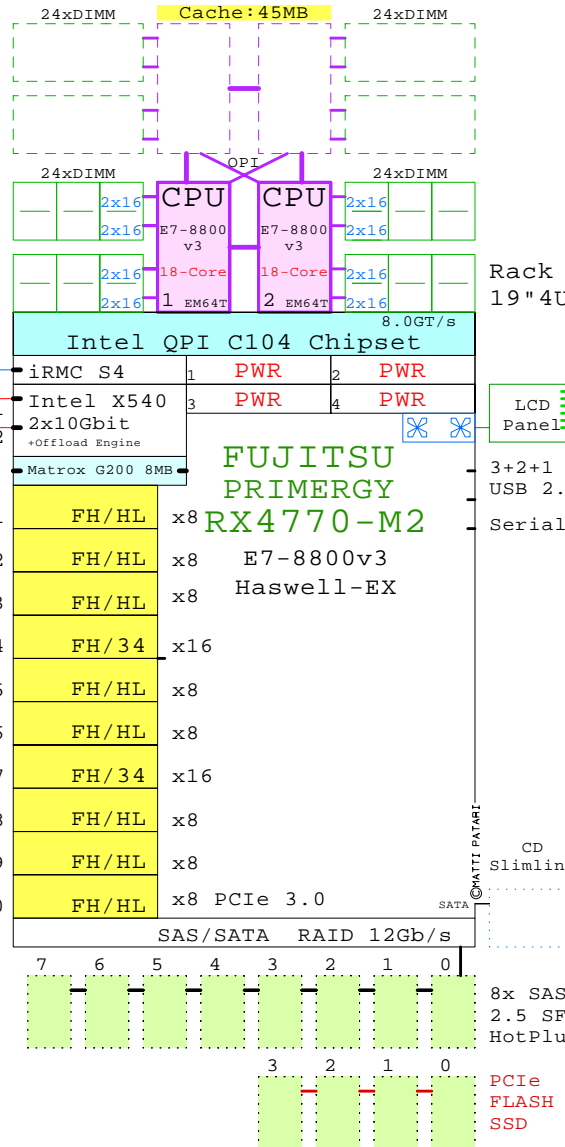

Max Memory
 96x 64GB=
6.1TB

Rack
 19" 4U

LCD Panel
 3+2+1
 USB 2.0
 Serial

CD Slimline



FUJITSU RX4770 M2
Xeon E7-8890v3

Internal Options:

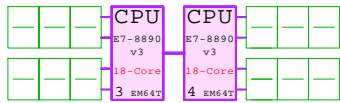

3-4 18-Core
E7-8890v3 45MB
2500MHz 165W

FUJI-2M16GB

2x16 DIMM Pairs

FUJI-2M32GB

FUJI-2M64GB

HDD-600GB
600GB 10k SAS 2.5"

HDD-900GB
900GB 10k SAS 2.5"

SSD-200GB
200GB SSD SAS 2.5"

PCIe-800GB
800GB FLA SSD PCIe

PCIe-1600GB
1.6TB Flash SSD 2.5"

FUJI-DVD
CD-RW/DVD

PCI-RAID
SAS RAID PCIe

PCI-1GbE
Ethernet 2ch

PCI-FC8
FibreChannel 8Gb 2-ch

PCI-INF40
InfiniBand 1-ch 40Gbs

Tip for detail printing:
- Zoom in area of interest
- Print, Current View

Example Configuration
x86-64

Intel Xeon E7-8890v3 x86-64
2500MHz 4P-18Core FUJI-RX4770M2

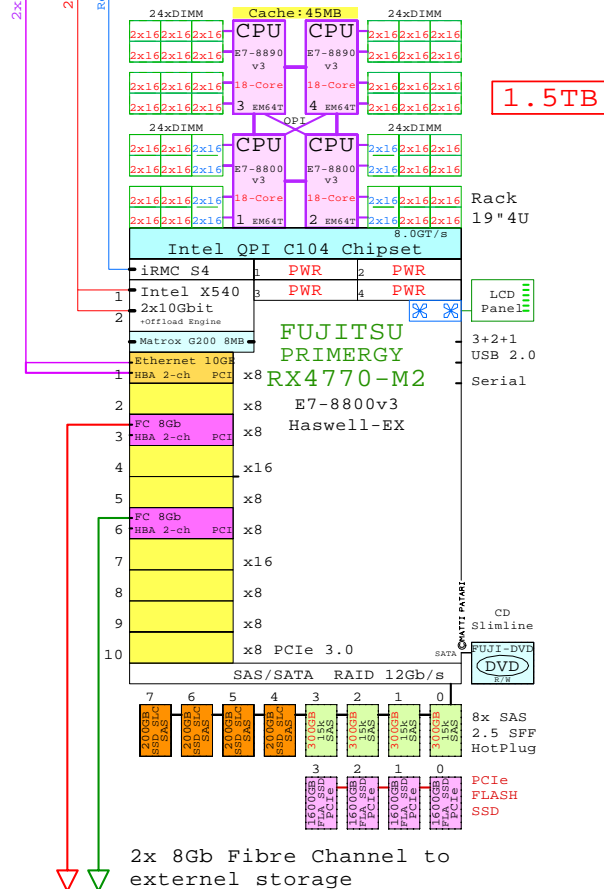

1.5TB

2x 8Gb Fibre Channel to external storage

Parts list of the 4P 18-Core 1.5TB RX4770-M2

Part Number	Qty	Description
FU-RX4770-M	1	Fuji RX4770-M2 2P 18-C E7-8890v3 45MB 25
FUJI-2M16GB	40	Fuji 2x16GB RX4770-M1 DIMM Memory
FUJI-DVD	1	FUJI CD-RW/DVD-ROM Option kit, slimline
FUJI-E78890	1	Fuji Xeon 2x E7-8890v3 18-Core 2.5GHz 45
HDD-300GB	4	Disk HDD 300GB 2.5" SAS 15k hot-plug
PCI-10GbE	1	Ethernet 2x 10GbE PCI HBA
PCI-FC8	2	Fibre Channel 8Gb 2-ch PCI HBA
PCIe-1600GB	4	Disk PCIe Flash 1600GB 2.5" SLC SSD
SSD-200GB	4	Disk SSD 200GB 2.5" SAS SLC hot-plug

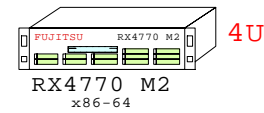

3-4
Processor+Memory
Plug in

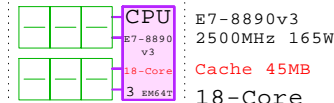

48x DIMM Pairs 2x16 2x32 2x64

Fujitsu iRMC S4 RJ-45 10/100/1000

Matrox G200 256MB

10x PCIe 3.0 slots Ethernet 10GbE HBA 2-ch PCI

FC 8Gb HBA 2-ch PCI

Storage SAS RAID based 2.5" HotPlug
HDD and SSD, 300GB...900GB

SSD HDD

4x PCIe-Flash-SSD

GE-link to this document: <http://www.goldeneggs.fi/documents/GE-FUJI-RX4770M2-A.pdf>

E7-8800v3
2500MHz 18-Core

Intel Xeon E7-8890v3 x86-64
2500MHz 4P-18Core FUJI-RX4770M2

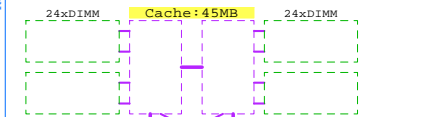

Max Memory
96x 64GB=
6.1TB

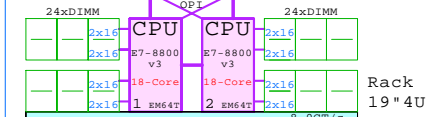

Intel QPI C104 Chipset

iRMC S4 PWR PWR PWR

Intel X540 2x10Gbit

Matrox G200 8MB

FH/HL x8 E7-8800v3

FH/HL x8 Haswell-EX

FH/34 x16

FH/HL x8

FH/HL x8

FH/HL x8

FH/HL x8 PCIe 3.0

8x SAS 2.5 SPF HotPlug

PCIe FLASH SSD

Golden Eggs Home:
<http://www.goldeneggs.fi>

© 2015 Matti Patari, All rights reserved.

GOLDEN EGGS Visuals™ Helsinki	08-Apr-2015	GE-FUJI-RX4770M2-A Matti.Patari@Kolumbus.fi
-------------------------------	-------------	--

FUJI RX4770-M2 4P E7-8890v3 2.5GH
GOLDEN EGGS Visuals, Helsinki

FUJITSU RX4770-M2 Intel E7-8890v3 4P/4U

Welcome to GoldenEggs x86 Visual Configurations

<http://www.goldeneggs.fi>

A picture is worth of one thousand words.
It talks all languages.

x86-64 servers: **Dell** **IBM** **HP** **Fujitsu** **SUN** **Acer** **Lenovo** and **Cisco**

4x Gigabit E Remote Manager

Intel Xeon E5-2699v3 x86-64
2300MHz 2P 18-Core **DELL-R730-A**

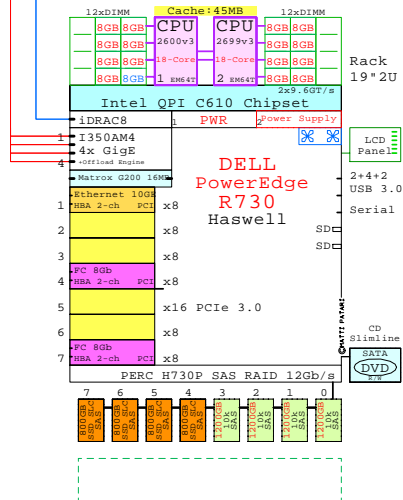

Intel Xeon E5-2699v3 x86-64
2300MHz 2P 18-Core **LENOVO-RD550-A**

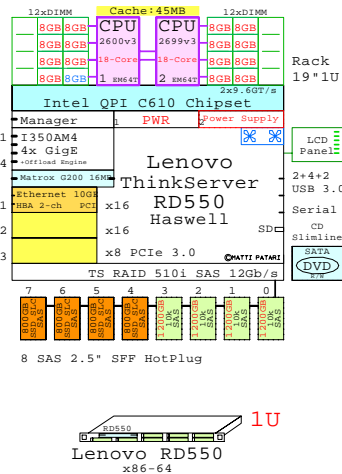

AMD Opteron 6172 x86-64
2100MHz 2P 12-Core **573088-421 EU**

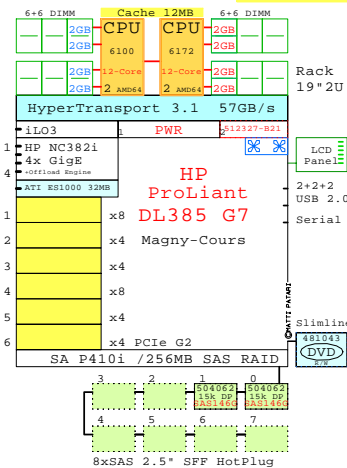

Dell Blades

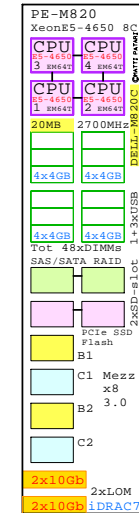

Fujitsu

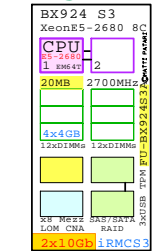

HP Blades

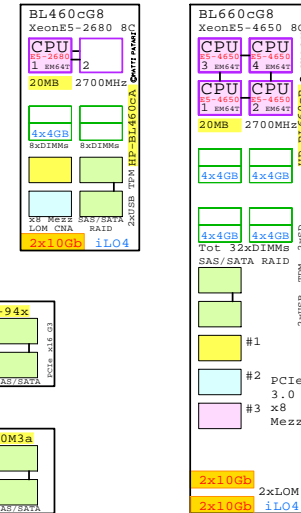

IBM Blades

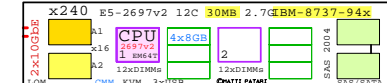

Cisco Blades

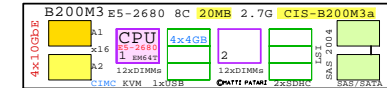

Donate

GoTo PayPal at:
www.GoldenEggs.fi

This site is fully funded from my pocket.
To keep this service running,
Your personal support is welcome.

Matti.Patari@Kolumbus.fi
Helsinki Finland

Older GoldenEggs sites:
<http://h18000.www1.hp.com/info/GECPQA/>

GE-links to x86 COMPARE Pictures:

- New <http://www.goldeneggs.fi/documents/GE-COMP-E78800V3-A.pdf>
<http://www.goldeneggs.fi/documents/GE-COMP-E52600V3-A.pdf>
<http://www.goldeneggs.fi/documents/GE-COMP-E74800V2-A.pdf>
<http://www.goldeneggs.fi/documents/GE-COMPARE-BLADE-A.pdf>
<http://www.goldeneggs.fi/documents/GE-INT-E5-MAP-A.pdf>

GE-link to GE 25 Year-Book

<http://www.goldeneggs.fi/documents/GE-25-YEAR-BOOK.pdf>

Follow GoldenEggs on Twitter:

@goldeneggsfi

GE-Welcome1

©2015 Matti Patari, All rights reserved.

GOLDEN EGGS Visuals™ Helsinki	29-Apr-2015	GE-Welcome1 Matti.Patari@Kolumbus.Fi
-------------------------------	-------------	---

Welcome to Visual Configurations
GOLDEN EGGS Visuals, Helsinki