

3-4  
Processor+Memory  
Plug in

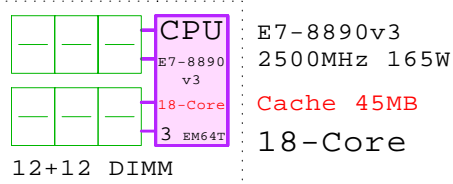

48x DIMM Pairs 2x16 2x32 2x64

iDRAC8 RJ-45 10/100

4x RJ-45 10Gb and 1Gb

Matrox G200 256MB

8x PCIe 3.0 slots

Qlogic 10GB  
DELL-10GE 2ch

Emulex 8GBx2  
DELL-FC2 2ch

Storage SAS RAID based 2.5" HotPlug  
HDD and SSD, 300GB...900GB

SSD HDD

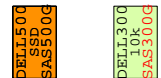

Storage PCIe based 2.5" HotPlug  
Flash SSD, 400GB...1.6TB

PCIe-Flash-SSD



4x Gigabit E  
Remote Manager

E7-8890v3  
2500MHz 18-Core

Intel Xeon E7-8890v3 x86-64  
2500MHz 4P-18Core DELL-R930-A

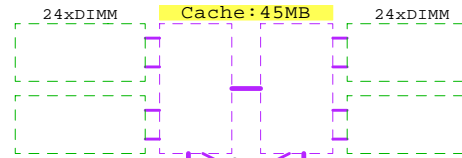

Max Memory  
96x 64GB=  
6.1TB

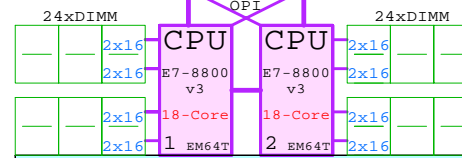

Rack  
19" 4U

Intel QPI C602J Chipset 8.0GT/s

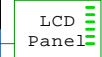
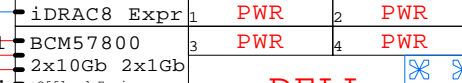

DELL  
PowerEdge  
R930

2+2+2  
USB 2.0  
Serial

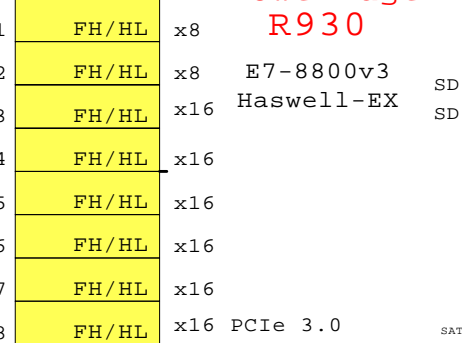

SD  
SD  
CD Slimline

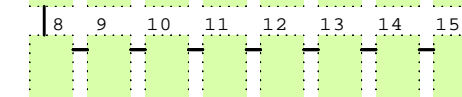
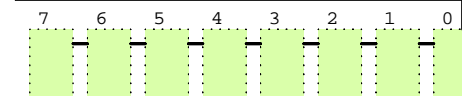

8xNVMe  
PCIe  
FLASH  
SSD  
HotPlug

DELL PE R930  
Xeon E7-8890v3

Internal Options:

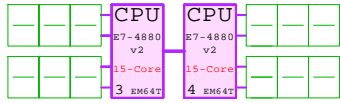

3-4 18-Core  
E7-8890v3 45MB  
2500MHz 165W

2x16 DELL-2M16GB

DIMM Pairs

2x32 DELL-2M32GB

2x64 DELL-2M64GB

DELL600 10k SAS9000 600GB 10k SAS 2.5"

DELL900 10k SAS9000 900GB 10k SAS 2.5"

DELL500 SSD SAS9000 500GB SSD SAS 2.5"

DELL800 800GB Flash SSD 2.5"

DELL 1.6TB 1.6TB Flash SSD 2.5"

DELL-DVD SATA CD-RW/DVD

DELL SAS RAID PERC SAS RAID

DELL-1GbE Dell GigabitE 2ch

Qlogic 10Gb Qlogic 10Gb CNA 2ch

DELL-FC2 Emulex FC 8Gb 2ch

Tip for detail printing:  
- Zoom in area of interest  
- Print, Print Current View

Example Configuration  
x86-64

Intel Xeon E7-8890v3 x86-64  
2500MHz 4P-18Core DELL-R930-A

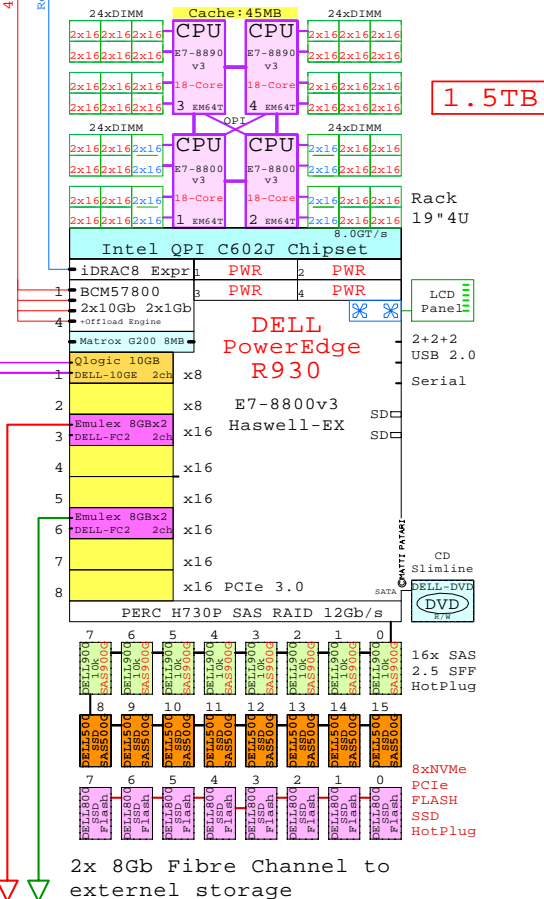

Parts list of the 4P 15-Core 1.5TB Dell R930

Part Number	Qty	Description
DELL-10GE	1	DELL Qlogic 10Gb CNA 2-ch adapter
DELL-2M16GB	40	DELL 2x16GB R920 DIMM Memory
DELL-500GB	8	Dell 500GB SATA SSD hot-plug disk 2.5"
DELL-800GB	8	Dell 800GB PCIe Flash SSD 2.5" hot-plug
DELL-900GB	8	DELL 900GB SAS 10000r hot-plug disk 2.5"
DELL-DVD	1	DELL CD-RW/DVD-ROM Option kit, slimline
DELL-E78890	1	DELL Xeon 2x E7-8890v3 18-Core 2.5GHz 45
DELL-FC2	2	DELL Emulex FC 8Gb 2-ch PCIe HBA
DELL-R930-A	1	DELL R930 2P 18-C E7-8890v3 45MB 256GB 4

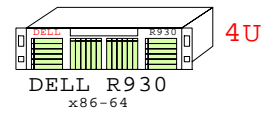

3-4 Processor+Memory Plug in

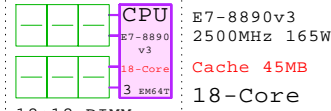

48x DIMM Pairs 2x16 2x32 2x64

iDRAC8 RJ-45 10/100

4x RJ-45 10Gb and 1Gb

Matrox G200 256MB

8x PCIe 3.0 slots

Storage SAS RAID based 2.5" HotPlug HDD and SSD, 300GB...900GB

Storage PCIe based 2.5" HotPlug Flash SSD, 400GB...1.6TB

GE-link to this document: <http://www.goldeneggs.fi/documents/GE-DELL-R930-A.pdf>

E7-8890v3  
2500MHz 18-Core

Intel Xeon E7-8890v3 x86-64  
2500MHz 4P-18Core DELL-R930-A

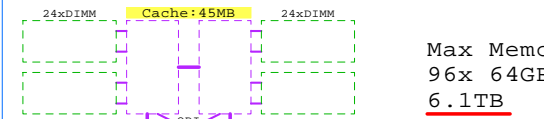

Max Memory  
96x 64GB=  
6.1TB

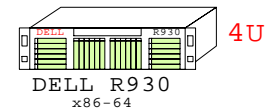
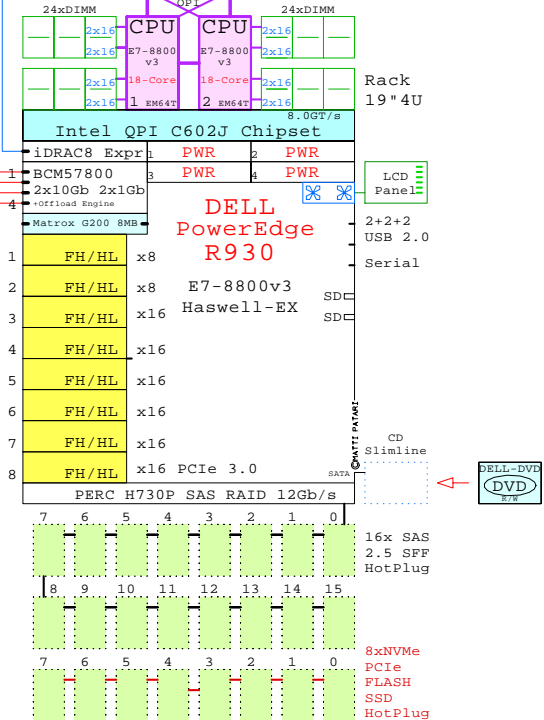

Golden Eggs Home:  
<http://www.goldeneggs.fi>

© 2015 Matti Patari, All rights reserved.

GOLDEN EGGS Visuals™ Helsinki	12-May-2015	GE-DELL-R930-A Matti.Patari@Kolumbus.fi
DELL PE R930 4P/4U E7-8890v3 2.5G		GOLDEN EGGS Visuals, Helsinki

DELL PE R930 Intel E7-8890v3 4P/4U

