

# GOLDEN EGGS

## Visual Cook Book for: HP X86-64 Servers

- 1 - HP ProLiant Family Map
- Rack Servers:
- 2 - DL165-G7 AMD Opteron 2P 1U
- 3 - DL360-G6 Intel Xeon 2P 1U
- 4 - DL380-G7 Intel Xeon 2P 2U
- 5 - DL385-G7 AMD Opteron 2P 2U
- 6 - DL580-G7 Intel Xeon 4P 4U
- 7 - DL585-G7 AMD Opteron 4P 4U
- 8 - DL785-G6 AMD Opteron 8P 7U
- 9 - DL980-G7 Intel Xeon 8P 8U
- Tower Servers:
- 10 - ML150-G6 Intel Xeon 2P 5U
- 11 - ML310-G5 Intel Xeon 1P 5U
- 12 - ML350-G6 Intel Xeon 2P 5U
- 13 - ML370-G6 Intel Xeon 2P 4U

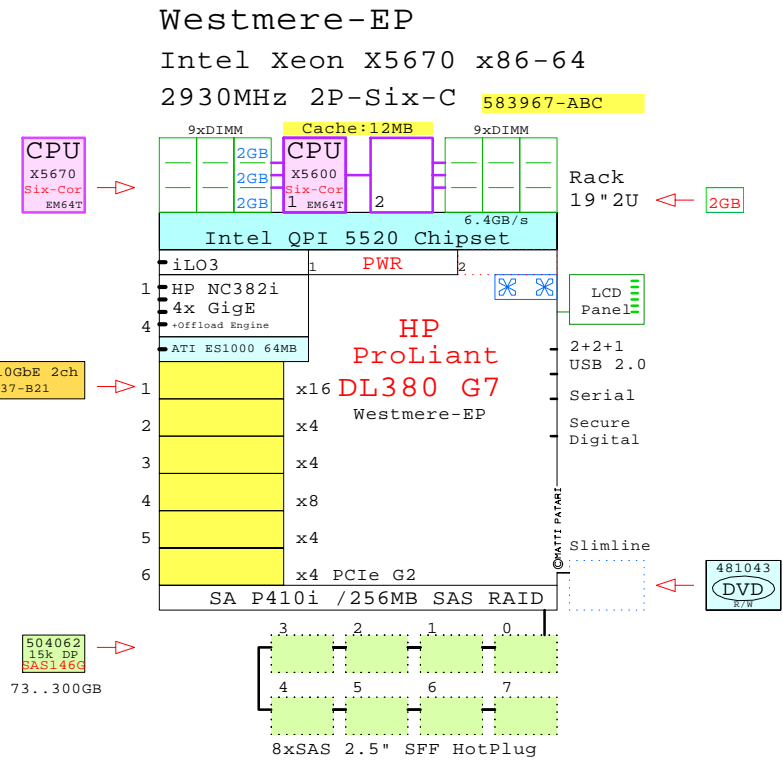

This document is a collection of HP x86-64 servers. It is prepared for End-customers, Partners and Sales personnel.  
A picture talks all languages.

Created by:  
 Matti.Patari@Kolumbus.Fi Helsinki  
 Tip for detail printing:  
 - Zoom in area of interest  
 - Print, Print Current View

Golden Eggs Home:  
<http://www.goldeneggs.fi>

GE-HP-BOOK-2011.pdf  
 © 2011 Matti Patari, All rights reserved.

GOLDEN EGGS Visuals™ Helsinki	01-Jul-2011	GE-HP-X86B
	Matti.Patari@Kolumbus.Fi	
HP x86 Servers 2P 4P 8P Intel AMD GOLDEN EGGS Visuals, Helsinki		

# HP ProLiant x86 Server Family

GE-link to this document: <http://www.goldeneggs.fi/documents/GE-HP-FAMILY-A.pdf>

## HP Rack Servers

### Xeon 8P-8U

Intel Xeon X7560 x86-64  
2260MHz 8P-8Core

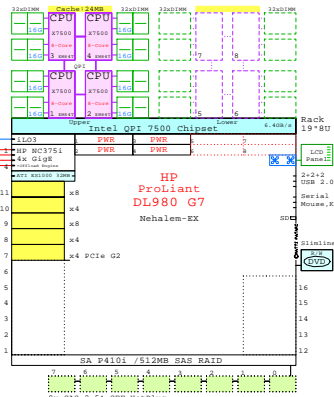

<http://www.goldeneggs.fi/documents/08-0P-DL980G7-A.pdf>

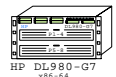

8U

### Opteron 8P-7U

AMD Opteron 8439SE x86-64  
2800MHz 8P Six-Core

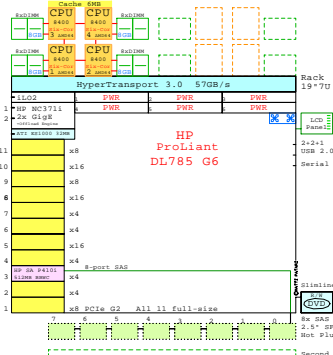

<http://www.goldeneggs.fi/documents/08-0P-DL785G6-A.pdf>

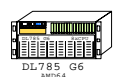

7U

### Xeon 4P-4U

Intel Xeon X7560 x86-64  
2260MHz 4P-8Core

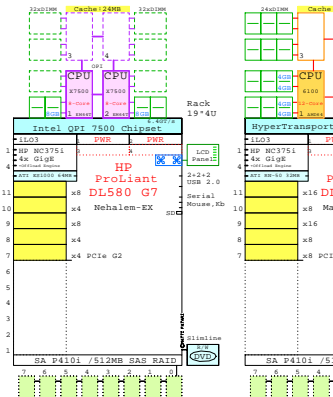

<http://www.goldeneggs.fi/documents/08-0P-DL580G7-A.pdf>

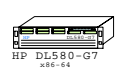

4U

### Opteron 4P-4U

AMD Opteron 6168 x86-64  
1900MHz 4P 12-Core

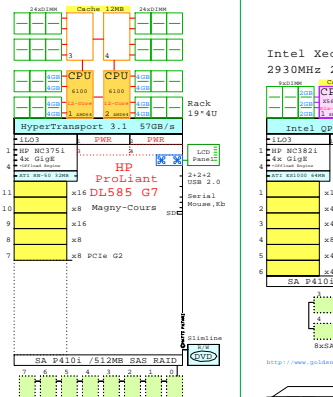

<http://www.goldeneggs.fi/documents/08-0P-DL585G7-A.pdf>

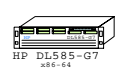

4U

### Xeon 2P-2U

Intel Xeon X5670 x86-64  
2930MHz 2P-Six-C

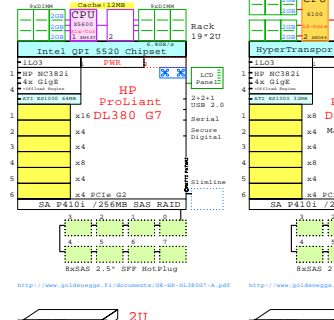

<http://www.goldeneggs.fi/documents/08-0P-DL380G7-A.pdf>



2U

### Opteron 2P-2U

AMD Opteron 6172 x86-64  
2100MHz 2P 12-Core

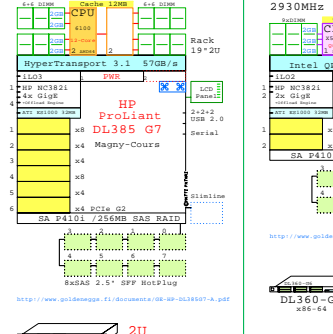

<http://www.goldeneggs.fi/documents/08-0P-DL385G7-A.pdf>



2U

### Xeon 2P-1U

Intel Xeon X5570 x86-64  
2930MHz 2P-Quad

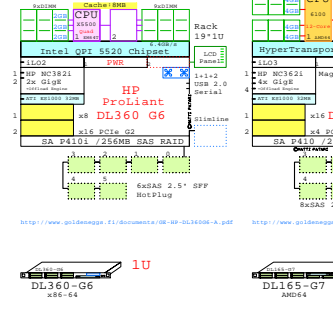

<http://www.goldeneggs.fi/documents/08-0P-DL360G6-A.pdf>



1U

### Opteron 2P-1U

AMD Opteron 6172 x86-64  
2100MHz 2P 12-Core

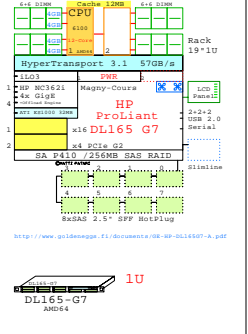

<http://www.goldeneggs.fi/documents/08-0P-DL165G7-A.pdf>



1U

## HP Tower Servers

### Xeon 2P-4U

Intel Xeon E5540 x86-64  
2530MHz 2P-Quad

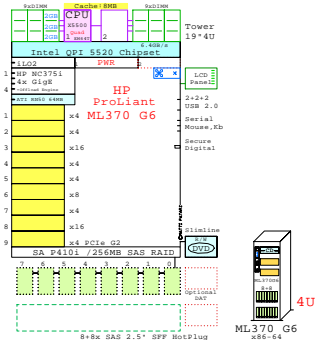

<http://www.goldeneggs.fi/documents/08-0P-ML370G6-A.pdf>

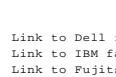

4U

### Xeon 2P-5U

Intel Xeon X5650 x86-64  
2260MHz 2P-Six-C

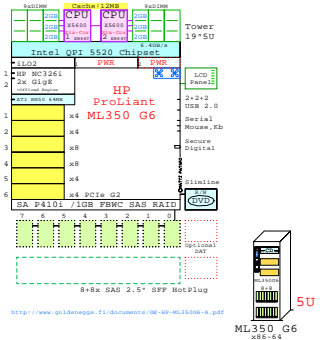

<http://www.goldeneggs.fi/documents/08-0P-ML350G6-A.pdf>

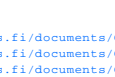

5U

### Xeon 2P-5U

Intel Xeon E5520 x86-64  
2260MHz 2P-Quad

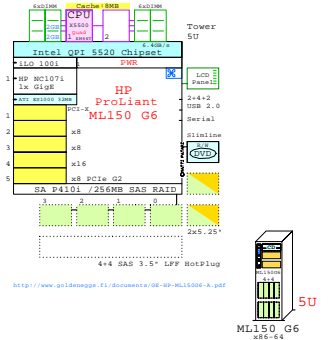

<http://www.goldeneggs.fi/documents/08-0P-ML150G6-A.pdf>



5U

### Xeon 1P-5U

Intel Core2 E8400 x86-64  
3000MHz 1P-Dual

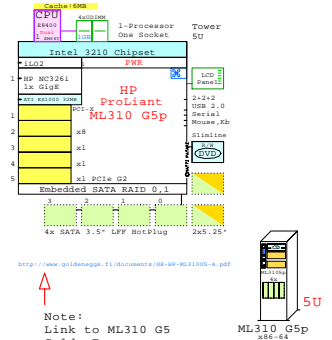

<http://www.goldeneggs.fi/documents/08-0P-ML310G5p-A.pdf>



5U

Note:  
Link to ML310 G5  
GoldenEggs  
document

Link to Dell family: <http://www.goldeneggs.fi/documents/GE-DELL-FAMILY-A.pdf>  
 Link to IBM family: <http://www.goldeneggs.fi/documents/GE-IBM-FAMILY-A.pdf>  
 Link to Fujitsu family: <http://www.goldeneggs.fi/documents/GE-FUJITSU-FAMILY-A.pdf>  
 Link to SUN family: <http://www.goldeneggs.fi/documents/GE-SUN-FAMILY-A.pdf>

Created by:  
Matti.Patari@Kolumbus.Fi  
Helsinki

Tip for detail printing:  
- Zoom in area of interest  
- Print, Print Current View

GoldenEggs Home:  
<http://www.goldeneggs.fi>

©2011 Matti Patari, All rights reserved.

GOLDEN EGGS fi amla Helsinki	30-Jan-2011 fi amla Helsinki	GE-HP-FAMILY-A fi amla Helsinki
HP x86 Server 8P,4P,2P Intel,AMD		GOLDEN EGGS Visuals, Helsinki

HP DL165-G7  
AMD Opteron

Internal Options:

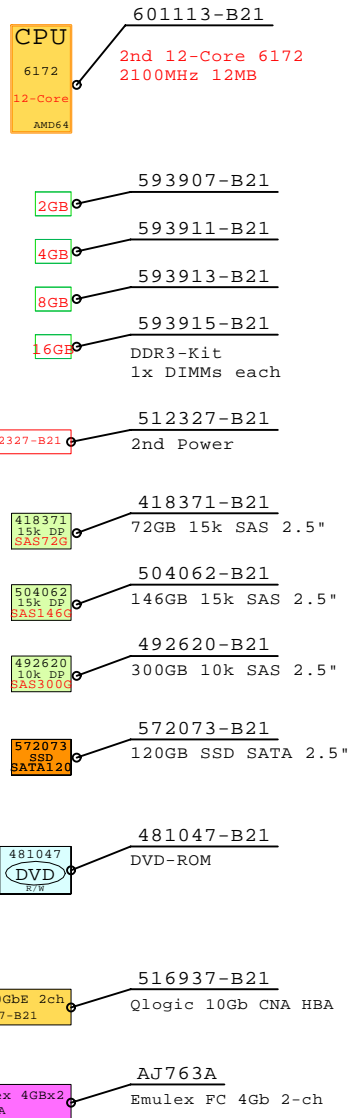

Example Configuration  
x86-64

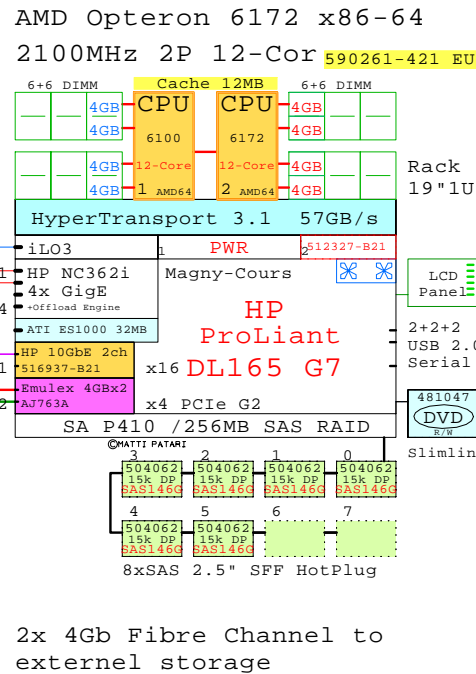

2x 4Gb Fibre Channel to external storage

Parts list for the 2P 1U 12-Core HP DL165-G7 system above

Part Number	Qty	Description
1	590261-421	1 DL165 G7 1P 12C 6172 2.1GH 16GB AMD64 SA
1.1	481047-B21	1 CD-RW/DVD-ROM Option kit, slimline
1.2	504062-B21	6 HP 146GB 3G 15k 2.5" SAS DualPort HDD
1.3	512327-B21	1 DL380 G6 second power supply WW
1.4	516937-B21	1 HP 10GbE PCI-e G2 DualPort NIC
1.5	593911-B21	4 4GB DDR3 kit 1x4GB DL385G7
1.6	601113-B21	1 Opteron 12C 6172-12MB 2100MHz DL165G7
1.7	AJ763A	1 HP Emulex FC 8Gb 2-ch PCIe HBA

Magny-Cours  
2100MHz Twelve-Core

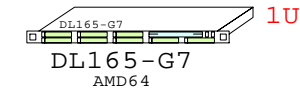
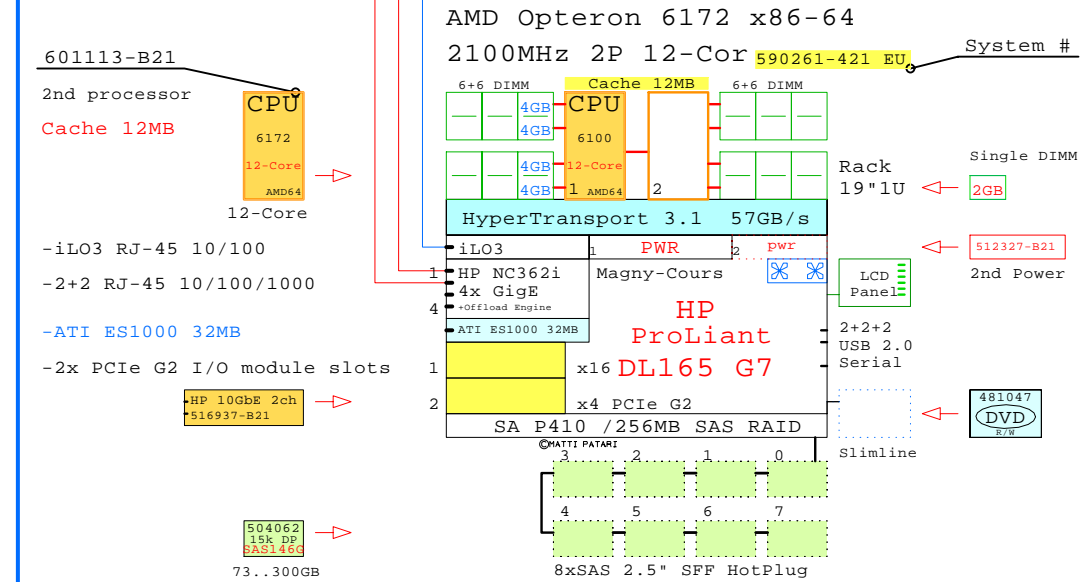

MS Windows Server 2003 and 2008  
LINUX: Red Hat, SuSE  
VMware Virtualization Software

Tip for detail printing:  
- Zoom in area of interest  
- Print, Print Current View

Golden Eggs Home:  
<http://www.goldeneggs.fi>

© 2010 Matti Patari, All rights reserved.

GOLDEN EGGS Visuals™ Helsinki	02-May-2010	GE-HP-DL165G7-A
		Matti.Patari@Goldeneggs.Fi

HP DL165-G7 AMD Opteron 12-Core  
GOLDEN EGGS Visuals, Helsinki

HP DL165-G7 AMD Twelve-Core 2P/1U

++ Plus many more std PCIe I/O modules...

HP DL360-G6  
Xeon 5500

Internal Options:

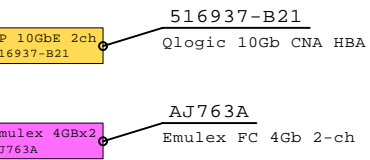
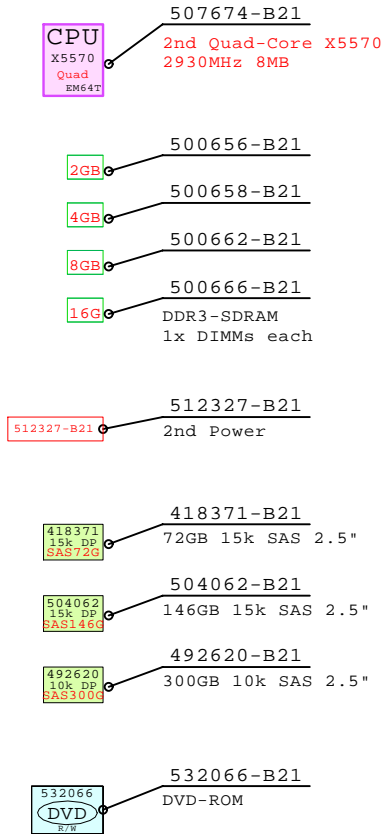

++ Plus many more std PCIe I/O modules...

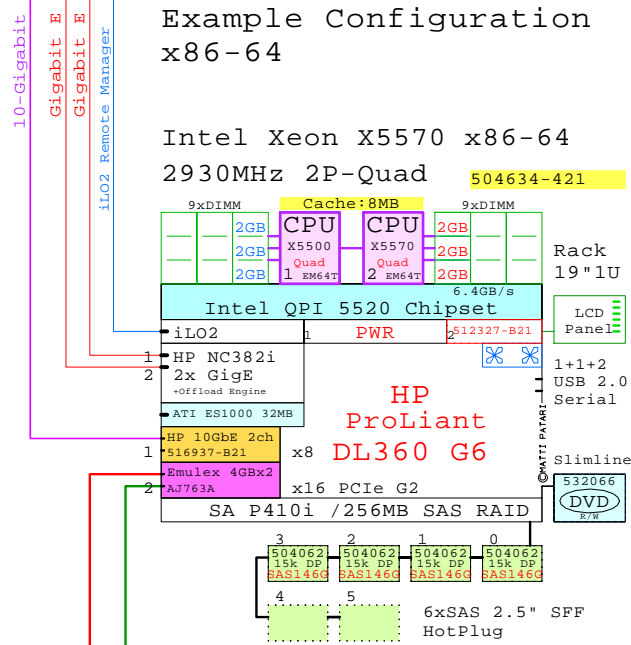

2x 4Gb Fibre Channel to external storage

Parts list for the 2P Quad-Core HP DL360-G6 system above

Part Number	Qty	Description
504634-421	1	HP DL360-G6 2P I QC X5570-8MB 6GB 1U
500656-B21	3	HP 2GB 2Rx8 PC3-10600R-9 kit 1x2GB
504062-B21	4	HP 146GB 3G 15k 2.5" SAS DualPort HDD
507674-B21	1	Xeon QC X5570-8MB 2.93GHz for DL360G6
512327-B21	1	DL380 G6 second power WW
516937-B21	1	HP 10GbE PCI-e G2 DualPort NIC
532066-B21	1	HP CD-RW/DVD-ROM Option kit DL360G6
AJ763A	1	HP Emulex FC 4Gb 2-ch HBA

Nehalem EP  
2930MHz Quad-Core

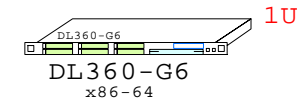
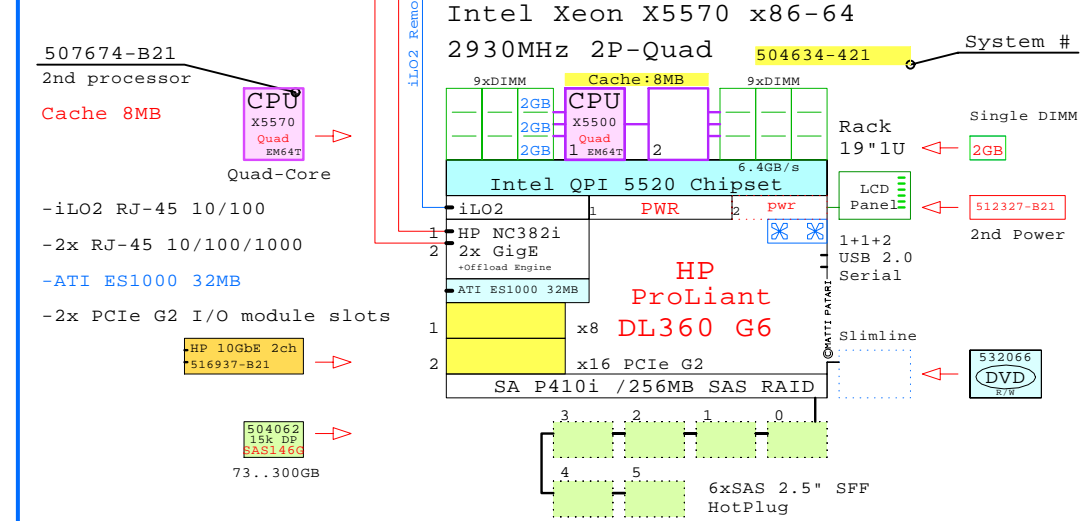

MS Windows Server 2003 and 2008  
LINUX: Red Hat, SuSE  
VMware Virtualization Software

Tip for detail printing:  
- Zoom in area of interest  
- Print, Print Current View

Golden Eggs Home:  
<http://www.goldeneggs.fi>

© 2010 Matti Patari, All rights reserved.

GOLDEN EGGS Visuals™ Helsinki	11-Mar-2010	GE-HP-DL360G6-A
		Matti.Patari@Goldeneggs.Fi

HP ProLiant DL360-G6 X5570 2930Mz  
GOLDEN EGGS Visuals, Helsinki

HP DL360-G6 Intel 5500 2P/1U

HP DL380-G7  
Xeon 5600

Internal Options:

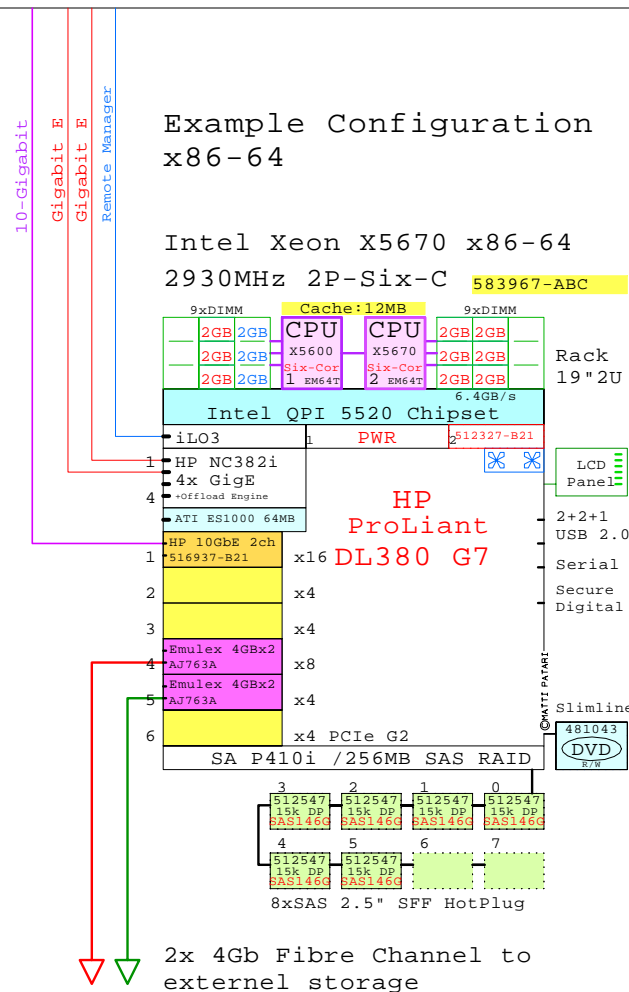
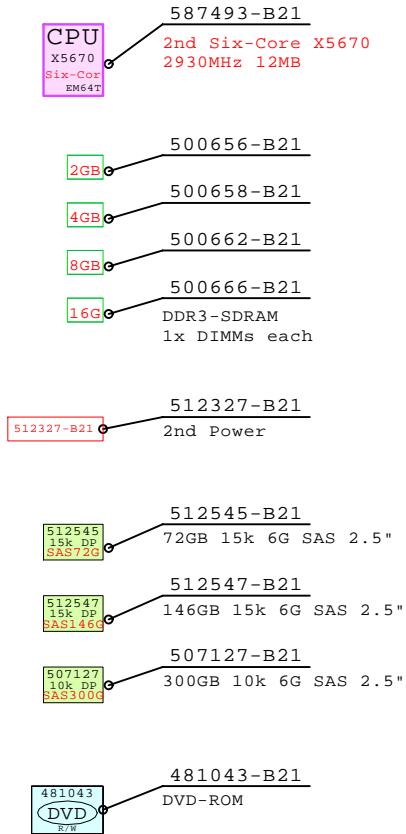

2x 4Gb Fibre Channel to external storage

Parts list for the 2P Six-Core HP DL380-G7 system above

Part Number	Qty	Description
583967-ABC	1	HP DL380-G7 2P I 6C X5670-12MB 6GB 2U
481043-B21	1	HP CD-RW/DVD-ROM Option kit, slimline
500656-B21	9	HP 2GB 2Rx8 PC3-10600R-9 kit 1x2GB
512327-B21	1	DL380 G6 second power supply WW
512547-B21	6	HP 146GB 6G 15k 2.5" SAS DualPort HDD
516937-B21	1	HP 10GbE PCI-e G2 DualPort NIC
587493-B21	1	Xeon 6C X5670-12MB 2.93GHz for DL380G7
AJ763A	2	HP Emulex FC 8Gb 2-ch PCIe HBA

Westmere EP  
2930MHz Six-Core

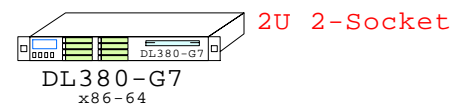
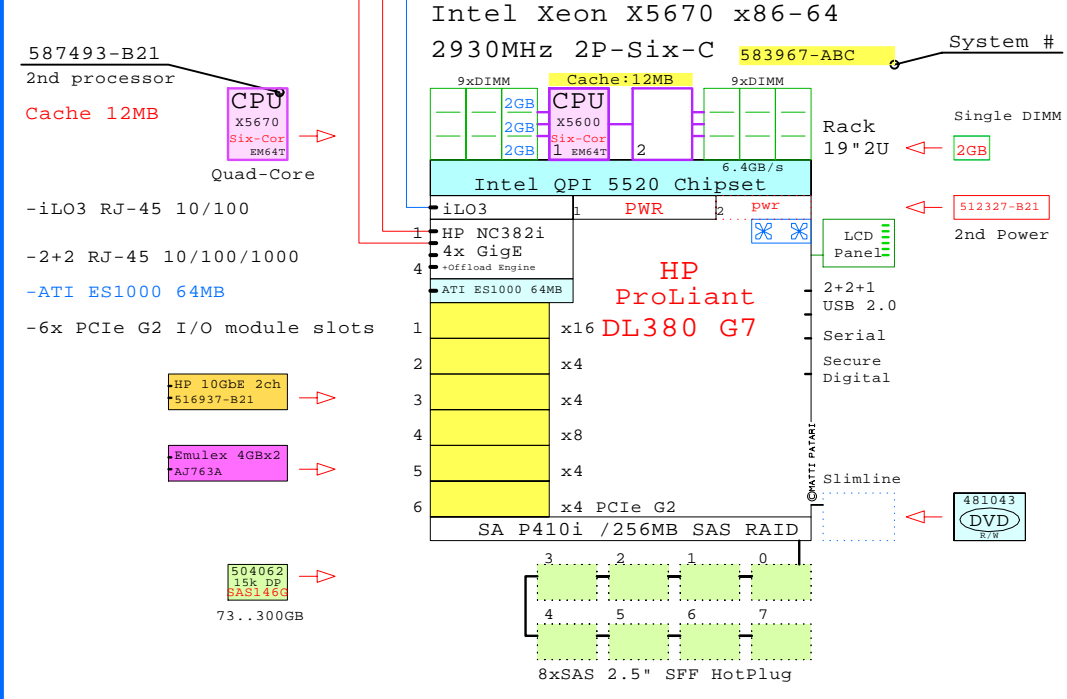

MS Windows Server 2003 and 2008  
LINUX: Red Hat, SuSE  
VMware Virtualization Software

Tip for detail printing:  
- Zoom in area of interest  
- Print, Print Current View

Golden Eggs Home:  
<http://www.goldeneggs.fi>

© 2010 Matti Patari, All rights reserved.

GOLDEN EGGS Visuals™ Helsinki	22-May-2010	GE-HP-DL380G7-A
		Matti.Patari@Goldeneggs.Fi

HP DL380-G7 Intel 5600 2P/2U

HP ProLiant DL380-G7 X5670 2930Mz  
GOLDEN EGGS Visuals, Helsinki

HP DL385-G7  
AMD Opteron

Internal Options:

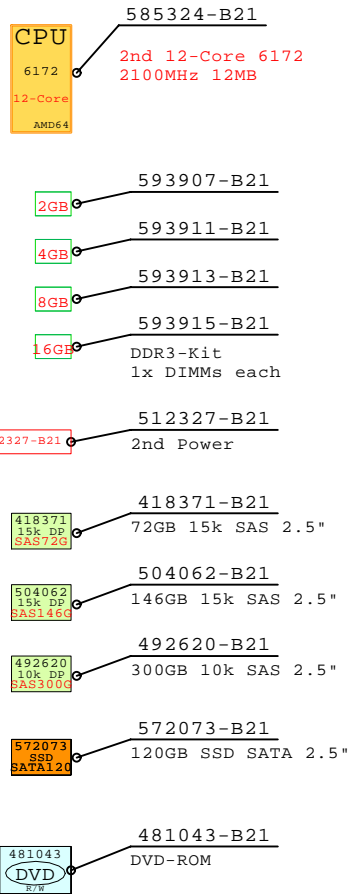

Example Configuration  
x86-64

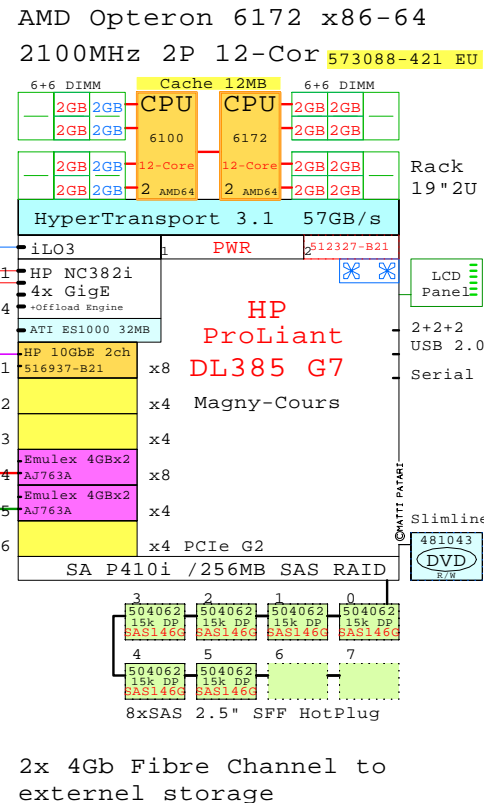

Parts list for the 2P 12-Core HP DL385-G7 system above

Part Number	Qty	Description
1	1	DL385 G7 1P 12C 6172 2.1GH 8GB AMD64 SAS
1.1	1	HP CD-RW/DVD-ROM Option kit, slimline
1.2	6	HP 146GB 3G 15k 2.5" SAS DualPort HDD
1.3	1	DL380 G6 second power supply WW
1.4	1	HP 10GbE PCI-e G2 DualPort NIC
1.5	1	Opteron 12C 6172-12MB 2100MHz for DL385G
1.6	12	2GB DDR3 kit 1x2GB DL385G7
1.7	2	HP Emulex FC 8Gb 2-ch PCIe HBA

Magny-Cours  
2100MHz Twelve-Core

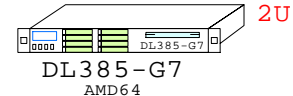
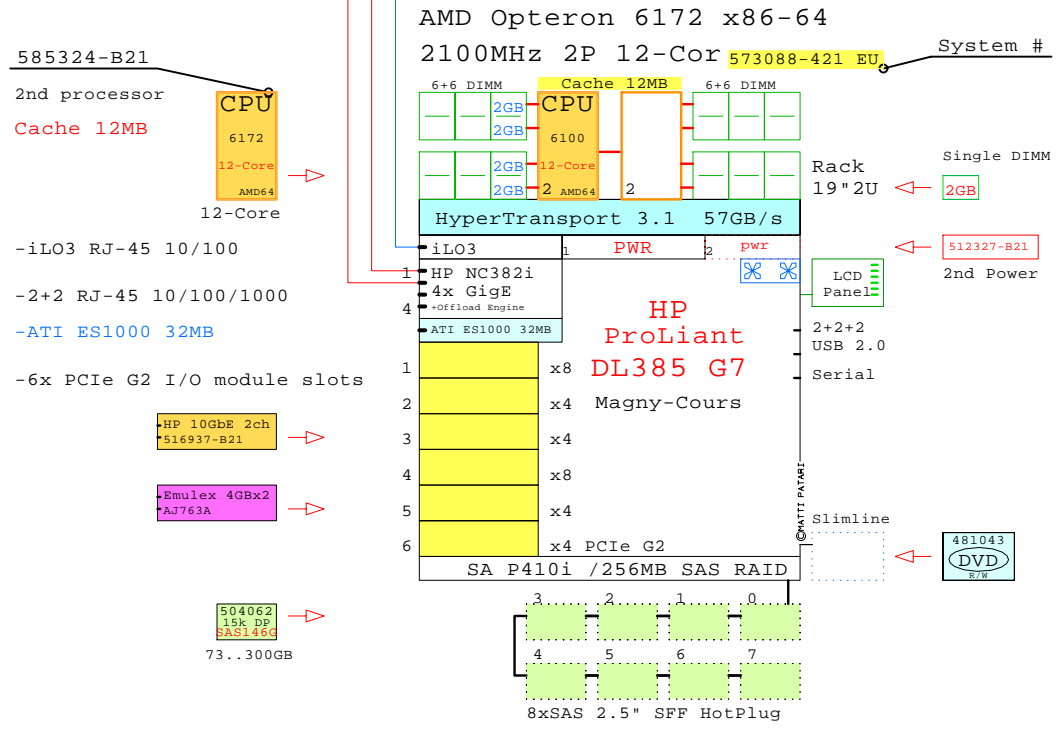

MS Windows Server 2003 and 2008  
LINUX: Red Hat, SuSE  
VMware Virtualization Software

Tip for detail printing:  
- Zoom in area of interest  
- Print, Print Current View

Golden Eggs Home:  
<http://www.goldeneggs.fi>

©2010 Matti Patari, All rights reserved.

GOLDEN EGGS Visuals™ Helsinki	30-Apr-2010	GE-HP-DL385G7-A
		Matti.Patari@Goldeneggs.Fi

HP DL385-G7 AMD Opteron 12-Core  
GOLDEN EGGS Visuals, Helsinki

++ Plus many more std PCIe I/O modules...

HP DL385-G7 AMD Twelve-Core 2P/2U

HP DL580-G7  
Xeon E7-4800

Internal Options:

- CPU** 643067-B21  
E7-4870  
10-Core  
EM64T  
3, 4 10-Core E7-4870  
2400MHz 30MB
- 588141-B21  
MemoryBook  
for 8x DIMM
- 8GB 500662-x2  
Pair of  
DDR3-SDRAM  
2x 4GB
- 16GB 500622-x2  
2x 8GB
- 32GB 500666-x2  
2x 16GB
- 500172-B21  
Power Supply
- 512545-B21  
72GB 15k 6G SAS 2.5"
- 512547-B21  
146GB 15k 6G SAS 2.5"
- 507127-B21  
300GB 10k 6G SAS 2.5"
- 572071-B21  
60GB SSD SATA 2.5"
- 572073-B21  
120GB SSD SATA 2.5"
- 412648-B21  
HP NC360T GbE  
HP NC360T 2ch Gige
- 468332-B21  
HP 10GbE 2ch  
HP NC522SFP 2ch 10GbE
- AH627A  
HP U320e SCSI HBA
- 462864-B21  
HP SA P410 512mb RAID
- AJ763A  
Emulex FC 8Gb 2-ch

Example Configuration  
x86-64

Intel Xeon E7-4870 x86-64  
2400MHz 4P-10Core 643065-42x

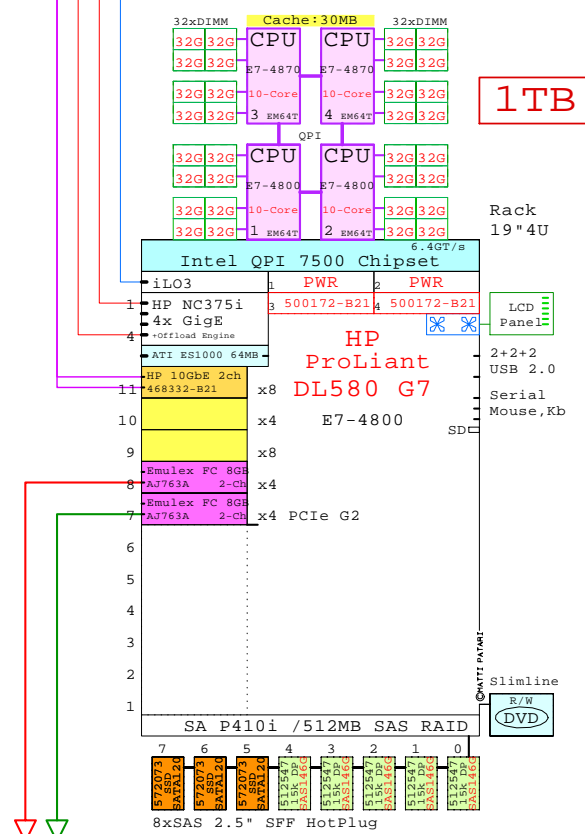

2x 8Gb Fibre Channel to external storage

Parts list for the 4P 1TB Ten-Core HP DL580-G7

Part Number	Qty	Description
468332-B21	1	HP NC522SFP 10GbE DualPort NIC
500172-B21	2	DL580 G7 second power supply WW
500666-x2	32	HP 32GB Memory 2x16GB, 2x 500666-B21
512547-B21	5	HP 146GB 6G 15k 2.5" SAS DualPort HDD
572073-B21	3	HP 120GB SATA 3G SSD hot-plug disk 2.5"
588141-B21	6	HP Memory Expansion Book DL580-G7
643065-42x	1	DL580 G7 4P 10-C E7-4870 30MB 16GB 4U
643067-B21	2	HP Xeon E7-4870 10-Core 2.4GHz 30MB Proc
AJ763A	2	HP Emulex FC 8Gb 2-ch PCIe HBA

Tip for detail printing:  
- Zoom in area of interest  
- Print, Print Current View

HP DL580-G7 Intel Ten-Core E7-4800 4P/4U

E7-4800  
2400MHz Ten-Core

Intel Xeon E7-4870 x86-64 System #  
2400MHz 4P-10Core 643065-42x

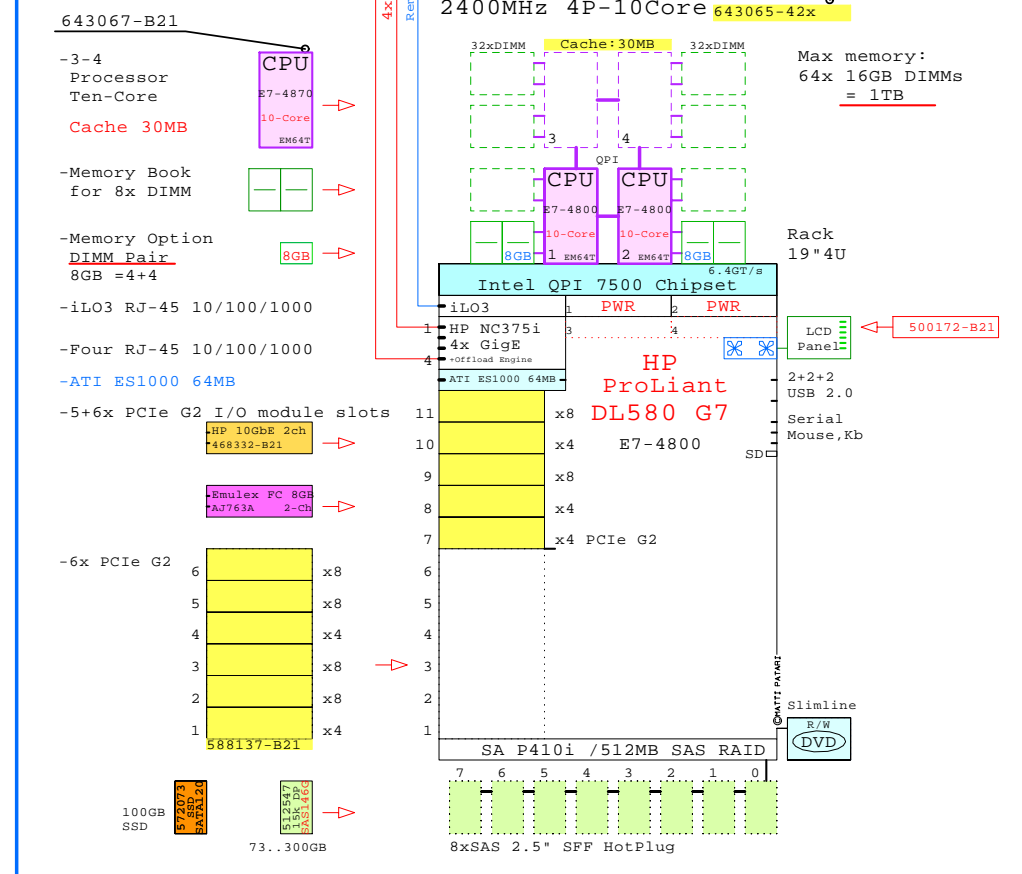

GE-link to this document: <http://www.goldeneggs.fi/documents/GE-HP-DL580G7-A.pdf>

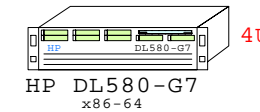

MS Windows Server 2003 and 2008 R2  
LINUX: Red Hat, SuSE  
VMware Virtualization Software  
Hyper-V

Golden Eggs Home:  
<http://www.goldeneggs.fi>

© 2010 Matti Patari, All rights reserved.

GOLDEN EGGS Visuals™ Helsinki	11-Jun-2011	GE-HP-DL580G7-A 2
	Matti.Patari@Kolumbus.fi	
HP DL580-G7 4P/4U E7-4870 2400MHZ GOLDEN EGGS Visuals, Helsinki		



HP DL585-G7  
AMD Opteron

Internal Options:

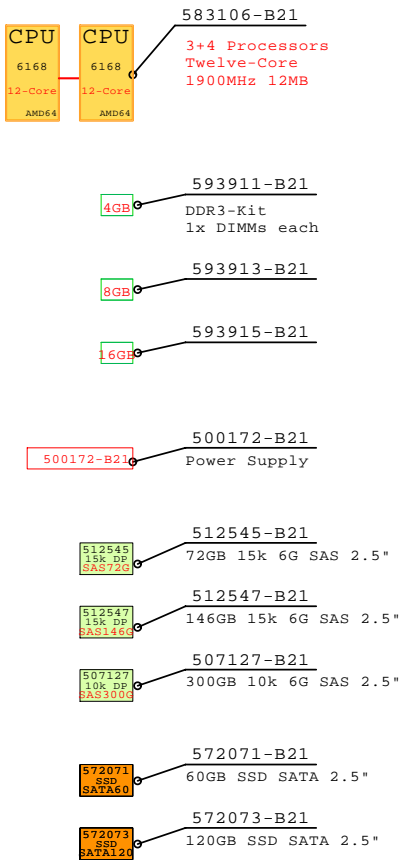

Example Configuration  
x86-64

AMD Opteron 6168 x86-64  
1900MHz 4P 12-Cor 583105-421 EU

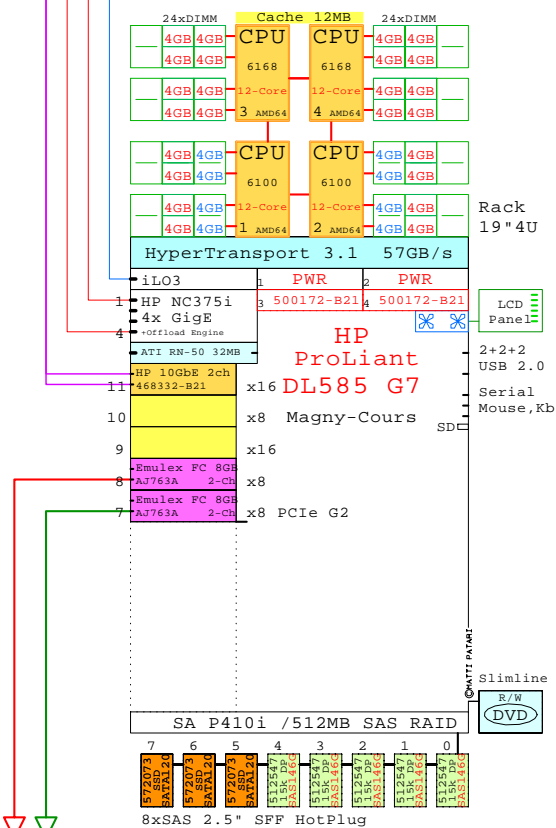

2x 8Gb Fibre Channel to  
external storage

Parts list for the 4P Twelve-Core HP DL585-G7 system above

	Part Number	Qty	Description
	583105-421	1	DL585 G7 2P 12C 6168 1.90GH 32GB AMD64 S
1.1	468332-B21	1	HP NC522SFP 10GbE DualPort NIC
1.2	500172-B21	2	DL580 G7 second power supply WW
1.3	512547-B21	5	HP 146GB 6G 15k 2.5" SAS DualPort HDD
1.4	572073-B21	3	HP 120GB SATA 3G SSD hot-plug disk 2.5"
1.5	583106-B21	1	Opteron Pair 12C 6168-12MB 1900MHz DL585
1.6	593911-B21	24	4GB DDR3 kit 1x4GB DL385G7
1.7	AJ763A	2	HP Emulex FC 8Gb 2-ch PCIe HBA

Magny-Cours  
1900MHz Twelve-Core

AMD Opteron 6168 x86-64  
1900MHz 4P 12-Cor 583105-421 EU

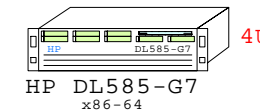
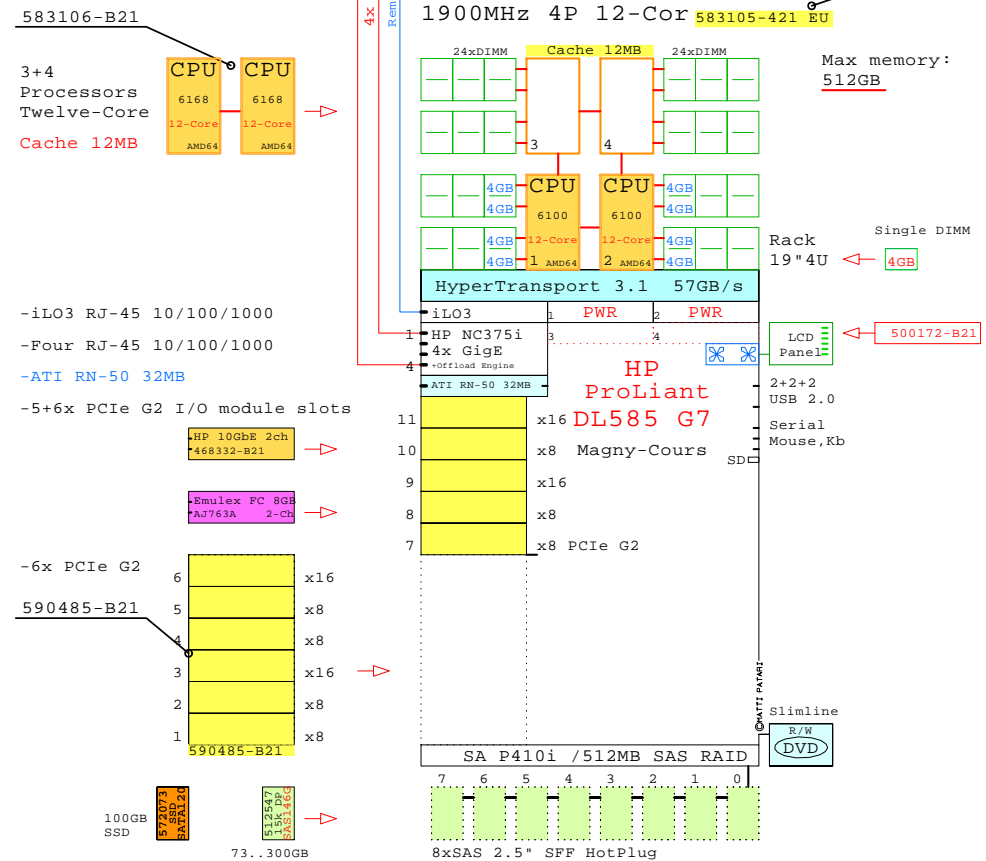

MS Windows Server 2003 and 2008 R2  
LINUX: Red Hat, SuSE  
VMware Virtualization Software  
Hyper-V

Golden Eggs Home:  
<http://www.goldeneggs.fi>

© 2010 Matti Patari, All rights reserved.

GOLDEN EGGS Visuals™ Helsinki	03-Jul-2010	GE-HP-DL585G7-A Matti.Patari@Goldeneggs.Fi
-------------------------------------	-------------	---

HP DL585-G7 AMD Opteron 12-Core  
GOLDEN EGGS Visuals, Helsinki

Tip for detail printing:  
- Zoom in area of interest  
- Print, Print Current View

HP DL585-G7 AMD Twelve-Core 4P/4U



HP DL785-G6  
AMD Opteron

Example Configuration

AMD Opteron 8439SE x86-64  
2800MHz 8P Six-Core

Internal Options:

- 497765-B21
- 497767-B21
- 408855-B21  
DDR2-SDRAM  
2x DIMMs each
- 418371-B21  
72GB 15k SAS 2.5"
- 504062-B21  
146GB 15k SAS 2.5"
- 492620-B21  
300GB 10k SAS 2.5"
- 572073-B21  
120GB SSD SATA 2.5"
- 412648-B21  
HP NC360T GB  
412648-B21 2ch
- 468332-B21  
HP 10GbE 2ch  
468332-B21
- 516937-B21  
HP 10GbE 2ch  
516937-B21
- 462864-B21  
HP SA P410 512 BBWC
- AJ763A  
Emulex FC 8Gb 2-ch

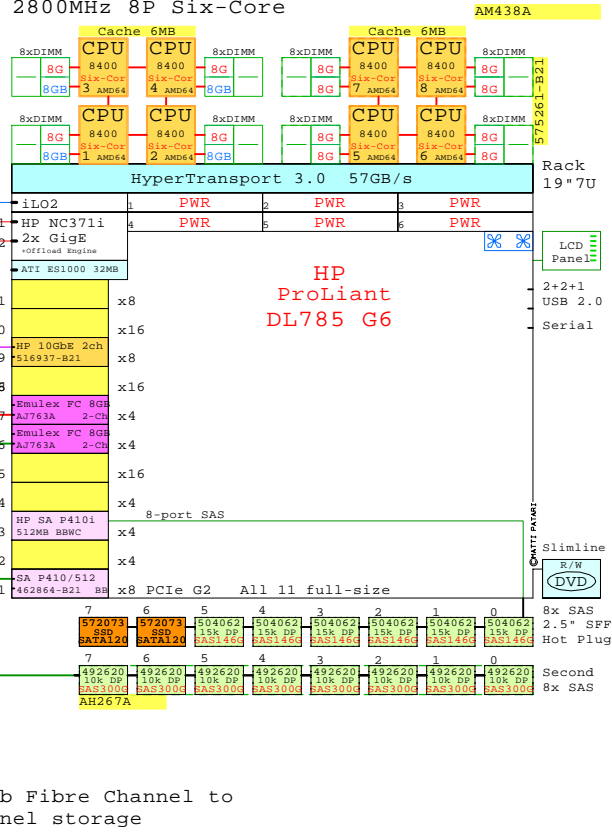
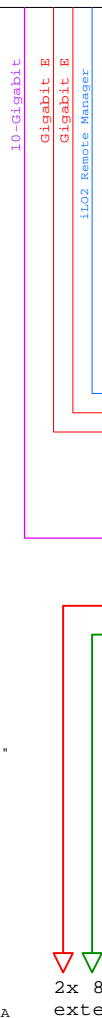

2x 8Gb Fibre Channel to external storage

Parts list for the 8P Six-Core HP DL785-G6 system above

	Part Number	Qty	Description
	AM438A	1	DL785-G6 8P 6C AMD8439SE 6MB 64GB 2.8GHZ
1	462864-B21	1	HP Smart Array P410/512MB BBWC HBA
1.1	497767-B21	4	Mem 8GB REG PC2-6400 DDR2 2x4GB Kit
1.2	504062-B21	6	HP 146GB 3G 15k 2.5" SAS DualPort HDD
1.3	516937-B21	1	HP 10GbE PCI-e G2 DualPort NIC
1.4	572073-B21	2	HP 120GB SATA SSD hot-plug disk 2.5"
1.5	575261-B21	1	5-8P CPU AMD64 6C 8439SE 2.8GHZ DL785-G6
1.6	497767-B21	8	Mem 8GB REG PC2-6400 DDR2 2x4GB Kit
1.6.1	AH267A	1	2nd Drive Gage 8xSFF SAS DL785-G6
1.7	492620-B21	8	HP 300GB 3G 10k 2.5" SAS DualPort HDD
1.7.1	492620-B21	8	HP 300GB 3G 10k 2.5" SAS DualPort HDD
1.8	AJ763A	2	HP Emulex FC 8Gb 2-ch PCIe HBA

++ Plus many more std PCIe I/O modules...

Optional P5-P8 CPUs  
-Four Processors  
-No memory

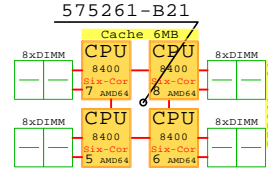

-iLO2 RJ-45 10/100  
-2x RJ-45 GigE  
-ATI ES1000 32MB  
-11x PCIe G2 I/O  
Module Slots

Istanbul  
2800MHz Six-Core

AMD Opteron 8439SE x86-64  
2800MHz 8P Six-Core

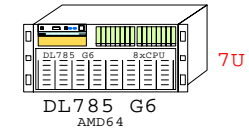
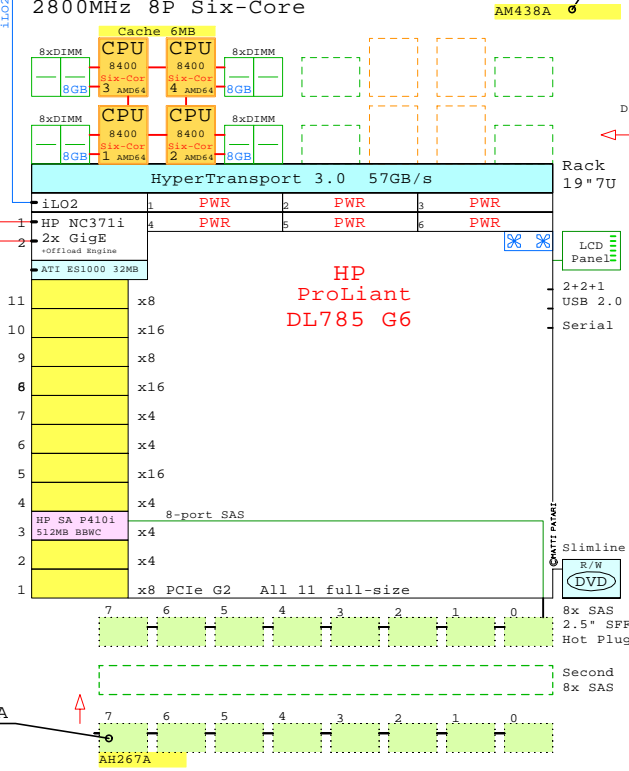
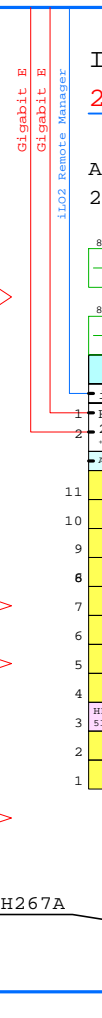

MS Windows Server 2003 and 2008  
LINUX: Red Hat, SuSE  
VMware Virtualization Software

Tip for detail printing:  
- Zoom in area of interest  
- Print, Print Current View

Golden Eggs Home:  
<http://www.goldeneggs.fi>

© 2010 Matti Patari, All rights reserved.

GOLDEN EGGS Visuals™ Helsinki	19-Mar-2010	GE-HP-DL785G6-A
		Matti.Patari@Goldeneggs.Fi

HP DL785-G6 AMD Opteron Six-Core  
GOLDEN EGGS Visuals, Helsinki

HP DL785-G6 AMD Six-Core 8P/7U

HP DL980-G7  
Xeon X7560

Example Configuration  
x86-64

Internal Options:

- 597871-B21  
Cache: 24MB  
CPU X7560 8-Core  
CPU X7560 8-Core
- 588141-B21  
MemoryBook for 8x DIMM
- 593339-x2  
Memory Option DIMM Pair 8GB =4+4
- 500622-x2  
2x 8GB
- 500666-x2  
2x 16GB
- 578322-B21  
One Power Supply
- 512545-B21  
72GB 15k 6G SAS 2.5"
- 512547-B21  
146GB 15k 6G SAS 2.5"
- 507127-B21  
300GB 10k 6G SAS 2.5"
- 572071-B21  
60GB SSD SATA 2.5"
- 572073-B21  
120GB SSD SATA 2.5"
- 503746-B21  
HP NC112T
- 412648-B21  
HP NC360T 2ch GigE
- 468332-B21  
HP NC522SFP 2ch 10GbE
- AH627A  
HP U320e SCSI HBA
- 462828-B21  
SA P212/256
- AJ763A  
Emulex FC 8Gb 2-ch

Intel Xeon X7560 x86-64  
2260MHz 8P-8Core

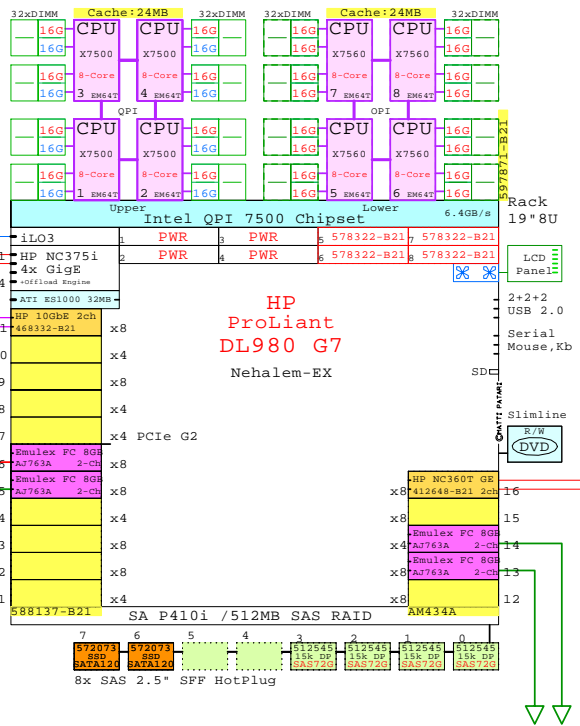

HP ProLiant DL980 G7  
Nehalem-EX

2x 8Gb Fibre Channel to external storage

Parts list for this 8P 8U Eight-Core HP DL980-G7

Part Number	Qty	Description
412648-B21	1	HP NC360T PCIe GbE DualPort NIC
468332-B21	1	HP NC522SFP 10GbE DualPort NIC
500622-x2	24	HP 16GB Memory 2x8GB, 2x 500622-B21
512545-B21	4	HP 72GB 6G 15k 2.5" SAS DualPort HDD
572073-B21	2	HP 120GB SATA 3G SSD hot-plug disk 2.5"
578322-B21	4	DL980 G7 1200W power supply WW
588137-B21	1	HP DL580-G7 6xPCIe expansion kit
588141-B21	8	HP Memory Expansion Book DL580-G7
597871-B21	1	HP DL980 4xXeon X7560 8-Core 2.26GHz 24M
980980-AAA	1	HP DL980-G7 128GB 4P 8-C X7560 24MB 8U
AJ763A	4	HP Emulex FC 8Gb 2-ch PCIe HBA
AM434A	1	HP DL980-G7 5xPCIe expansion kit

- Memory Option DIMM Pair 16GB =8+8
- Memory Book For 8x DIMM
- Processor Kit 5-8

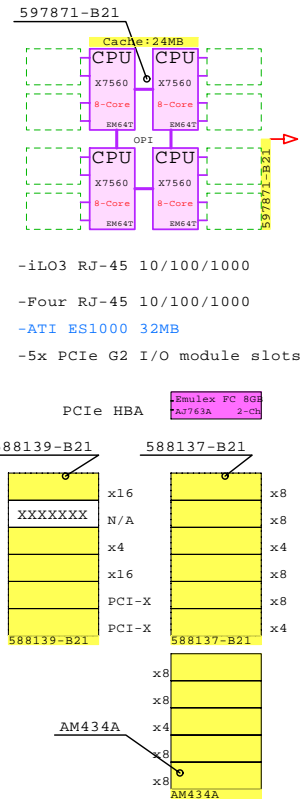

GE-link to this document: <http://www.goldeneggs.fi/documents/GE-HP-DL980G7-A.pdf>

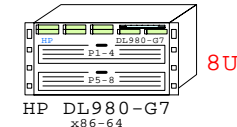

Nehalem-EX  
2260MHz Eight-Core 8-Sockets

Intel Xeon X7560 x86-64  
2260MHz 8P-8Core

MAX Memory 128x 16GB = 2TB

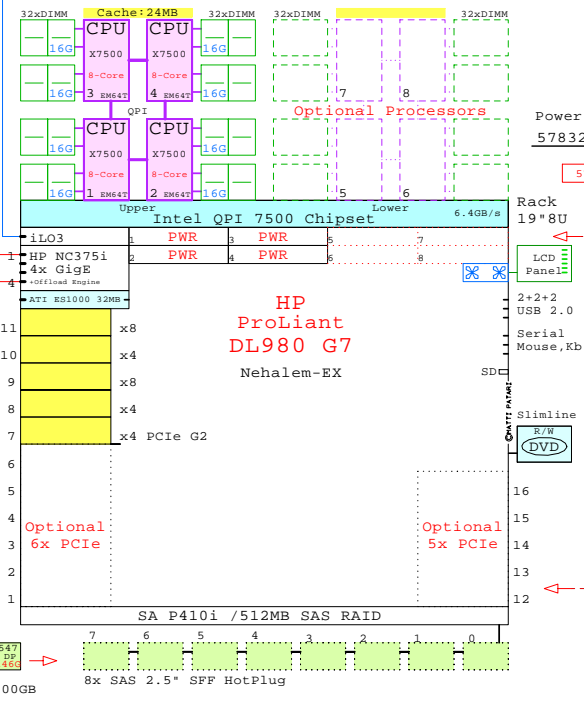

MS Windows Server 2003 and 2008 R2  
LINUX: Red Hat, SuSE  
VMware Virtualization Software  
Hyper-V

Tip for detail printing:  
- Zoom in area of interest  
- Print, Print Current View

Golden Eggs Home:  
<http://www.goldeneggs.fi>

© 2010 Matti Patari, All rights reserved.

GOLDEN EGGS Visuals™ Helsinki	01-Nov-2010	GE-HP-DL980G7-A
	Matti.Patari@Kolumbus.Fi	

HP ProLiant DL980-G7 Intel Eight-Core X7500 8P/8U

HP ProLiant DL980-G7 X7560 2260Mz  
GOLDEN EGGS Visuals, Helsinki

HP ML150-G6  
Xeon 5500

Internal Options:

- 507722-B21  
CPU E5520 Quad EM64T  
2nd Quad-Core E5520  
2260MHz 8MB
- 500656-B21  
2GB
- 500658-B21  
4GB
- 500662-B21  
8GB
- 500666-B21  
16GB  
DDR3-SDRAM  
1x DIMMs each
- 461135-B21  
750GB 7.2k DP 3G SAS 3.5"
- 461137-B21  
1TB 7.2k DP 3G SAS 3.5"
- 507616-B21  
2TB 7.2k DP 6G SAS 3.5"
- Q1522B  
HP DAT72 Tape drive
- 412648-B21  
HP NC360T 2ch GigE
- 468332-B21  
HP NC522SFP 2ch 10GbE
- AH627A  
HP U320e SCSI
- 462864-B21  
HP SA P410 512mb RAID
- AJ763A  
Emulex FC 8Gb 2-ch

Example Configuration  
x86-64

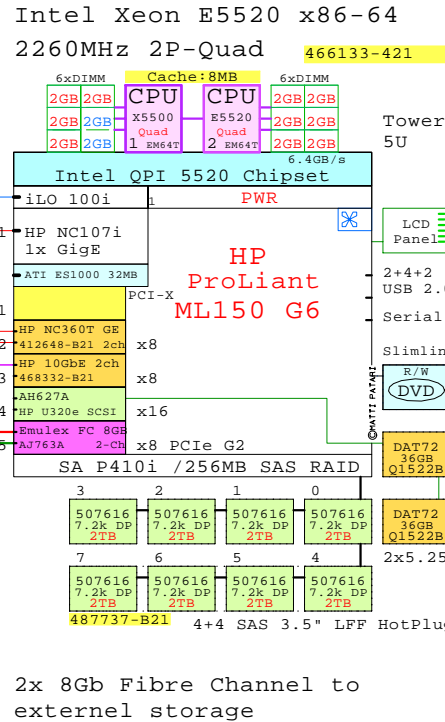

Parts list for the 2 Socket Quad-Core HP ML150-G6 system

Part Number	Qty	Description
1 466133-421	1	HP ML150-G6 2P I QC E5520-8MB 4GB Tower
1.1 412648-B21	1	HP NC360T PCIe GbE DualPort NIC
1.2 468332-B21	1	HP NC522SFP 10GbE DualPort NIC
1.3 487737-B21	1	HP ML150 G6 4 LFF 2nd Driv gage 3.5"
1.3.1 507616-B21	4	HP 2TB 7.2K 3.5" SAS DualPort HDD
1.4 500656-B21	10	HP 2GB 2Rx8 PC3-10600R-9 kit 1x2GB
1.5 507616-B21	4	HP 2TB 7.2K 3.5" SAS DualPort HDD
1.6 507722-B21	1	Xeon QC E5520-8MB 2.26GHz for ML150G6
1.7 AH627A	1	HP U320e SCSI Bus Adapter
1.8 AJ763A	1	HP Emulex FC 8Gb 2-ch PCIe HBA
1.9 Q1522B	2	HP DAT 72 36GB internal drive

Nehalem EP  
2260MHz Quad-Core

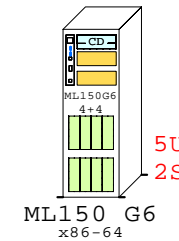
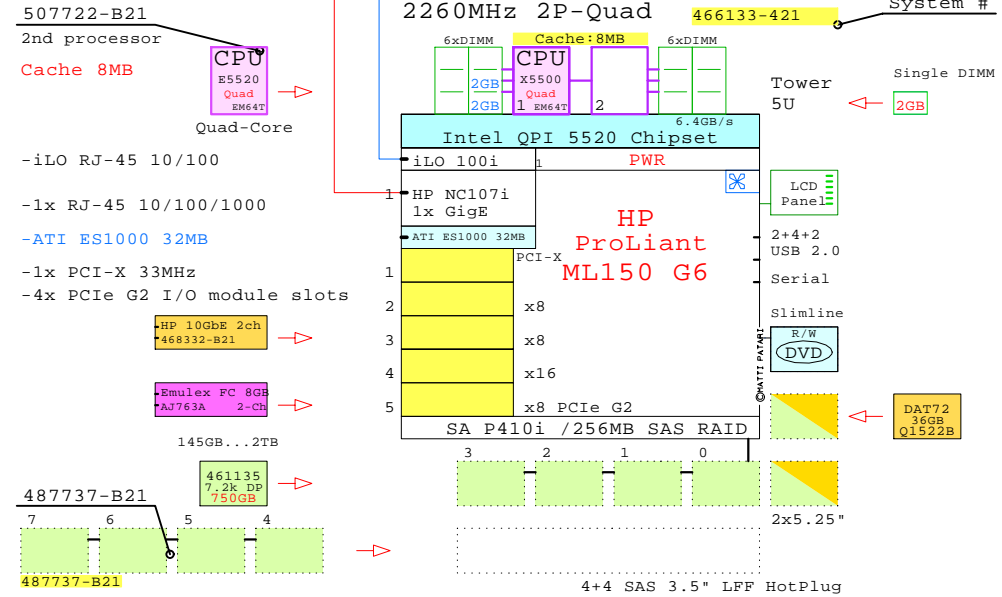

Tip for detail printing:  
- Zoom in area of interest  
- Print, Print Current View

Golden Eggs Home:  
<http://www.goldeneggs.fi>

© 2010 Matti Patari, All rights reserved.

GOLDEN EGGS Visuals™ Helsinki	06-Jun-2010	GE-HP-ML150G6-A Matti.Patari@Goldeneggs.Fi
-------------------------------	-------------	---

HP ProLiant ML150-G6 E5520 2260Mz  
GOLDEN EGGS Visuals, Helsinki

HP ProLiant ML150-G6 Intel 5500 2P/5U

HP ML310 G5p  
Intel E8400

Internal Options:

- 1GB DDR2-800  
1x UDIMM each
- 2GB
- 458928-B21  
500GB 7.2k 3G SATA 3.5"
- 454146-B21  
1TB 7.2k 3G SATA 3.5"
- 507632-B21  
2TB 7.2k 3G SATA 3.5"
- 379257-B21  
1.44MB Diskette Drive

Example Configuration  
x86-64

Intel Core2 E8400 x86-64  
3000MHz 1P-Dual 515867-421

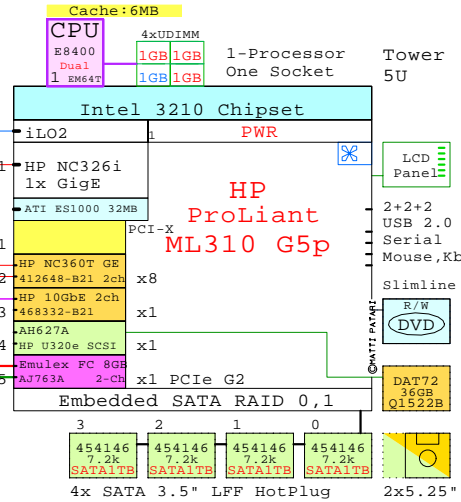

2x 8Gb Fibre Channel to external storage

- Q1522B HP DAT72 Tape drive
- 412648-B21 HP NC360T 2ch GigE
- 468332-B21 HP NC522SFP 2ch 10GbE
- AH627A HP U320e SCSI HBA
- 462864-B21 HP SA P410 512mb RAID
- AJ763A Emulex FC 8Gb 2-ch

Parts list for the 1-Socket Dual-Core HP ML310-G5p system

Part Number	Qty	Description
1	515867-421	1 HP ML310 G5p 1P I Dual E8400-6MB 1GB 5U
1.1	379257-B21	1 Floppy drive kit ML310 G5p
1.2	412648-B21	1 HP NC360T PCIe GbE DualPort NIC
1.3	450259-B21	3 HP 1GB Mem PC2-6400 UDIMM kit 1x1GB
1.4	454146-B21	4 HP 1TB SATA 3G 7.2k 3.5" LFF HDD
1.5	468332-B21	1 HP NC522SFP 10GbE DualPort NIC
1.6	AH627A	1 HP U320e SCSI Bus Adapter
1.7	AJ763A	1 HP Emulex FC 8Gb 2-ch PCIe HBA
1.8	Q1522B	1 HP DAT 72 36GB internal drive

Intel Core 2  
3000MHz Dual-Core

Intel Core2 E8400 x86-64  
3000MHz 1P-Dual 515867-421

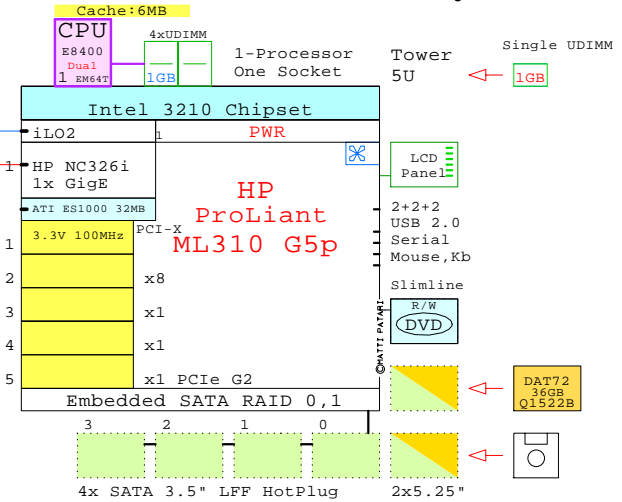

- iLO2 RJ-45 100/1000
- 1x RJ-45 10/100/1000
- ATI ES1000 32MB
- 1x PCI-X 100MHz 3.3V
- 4x PCIe G2 I/O module slots
- HP NC360T GE 412648-B21 2ch
- Emulex FC 8Gb AJ763A 2-ch
- 458928 500GB...2TB

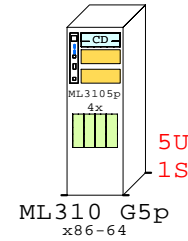

MS Windows Server 2003 and 2008 R2  
LINUX: Red Hat, SuSE  
VMware Virtualization Software  
Hyper-V

Tip for detail printing:  
- Zoom in area of interest  
- Print, Print Current View

Golden Eggs Home:  
<http://www.goldeneggs.fi>

© 2010 Matti Patari, All rights reserved.

GOLDEN EGGS Visuals™ Helsinki	01-Jul-2010	GE-HP-ML310G5-A Matti.Patari@Goldeneggs.Fi
-------------------------------	-------------	---

HP ProLiant ML310-G5p E8400 3GHZ  
GOLDEN EGGS Visuals, Helsinki

HP ProLiant ML310-G5p Intel E8400 1P/5U

HP ML350-G6  
Xeon 5600

Internal Options:

- 601240-B21  
CPU X5650 Six-Cor EM64T  
2nd Six-Core X5650  
2660MHz 12MB
- 500656-B21  
2GB
- 500658-B21  
4GB
- 500662-B21  
8GB
- 500666-B21  
16GB  
DDR3-SDRAM  
1x DIMMs each
- 512327-B21  
2nd Power
- 512545-B21  
72GB 15k 6G SAS 2.5"  
512545 15k DP SAS72G
- 512547-B21  
146GB 15k 6G SAS 2.5"  
512547 15k DP SA2146
- 507127-B21  
300GB 10k 6G SAS 2.5"  
507127 10k DP SA3300
- 572073-B21  
120GB SSD SATA 2.5"  
572073 SS SA7A12
- Q1522B  
HP DAT72 Tape drive  
DAT72 36GB Q1522B
- 412648-B21  
HP NC360T 2ch GigE  
+HP NC360T GE +412648-B21 2ch
- 468332-B21  
HP NC522SFP 2ch 10GbE  
+HP 10GbE 2ch +468332-B21
- AH627A  
HP U320e SCSI HBA  
+AH627A +HP U320e SCSI
- 462864-B21  
HP SA P410 512mb RAID  
+SA P410/512 +462864-B21 BB
- AJ763A  
Emulex FC 8Gb 2-ch  
+Emulex FC 8G +AJ763A 2-ch

Example Configuration  
x86-64

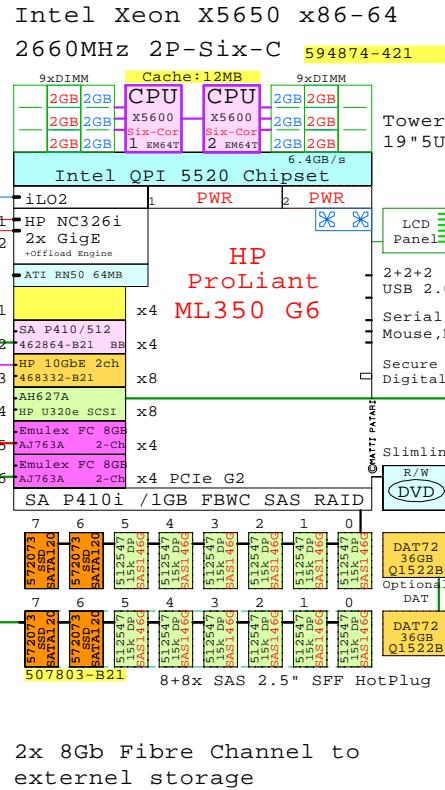

Parts list for the 2P Six-Core HP ML350-G6 system above

Part Number	Qty	Description
1	594874-421	1 HP ML350-G6 2P I 6C X5650-12MB 12GB 5U
1.1	462864-B21	1 HP Smart Array P410/512MB BBWC HBA
1.2	468332-B21	1 HP NC522SFP 10GbE DualPort NIC
1.3	500656-B21	6 HP 2GB 2Rx8 PC3-10600R-9 kit 1x2GB
1.4	507803-B21	1 HP ML350/370 G6 8 SFF 2nd Driv gage
1.4.1	512547-B21	6 HP 146GB 6G 15k 2.5" SAS DualPort HDD
1.4.2	572073-B21	2 HP 120GB SATA SSD hot-plug disk 2.5"
1.5	512547-B21	6 HP 146GB 6G 15k 2.5" SAS DualPort HDD
1.6	572073-B21	2 HP 120GB SATA SSD hot-plug disk 2.5"
1.7	AH627A	1 HP U320e SCSI Bus Adapter
1.8	AJ763A	2 HP Emulex FC 8Gb 2-ch PCIe HBA
1.9	Q1522B	2 HP DAT 72 36GB internal drive

Westmere EP  
2660MHz Six-Core

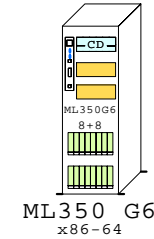
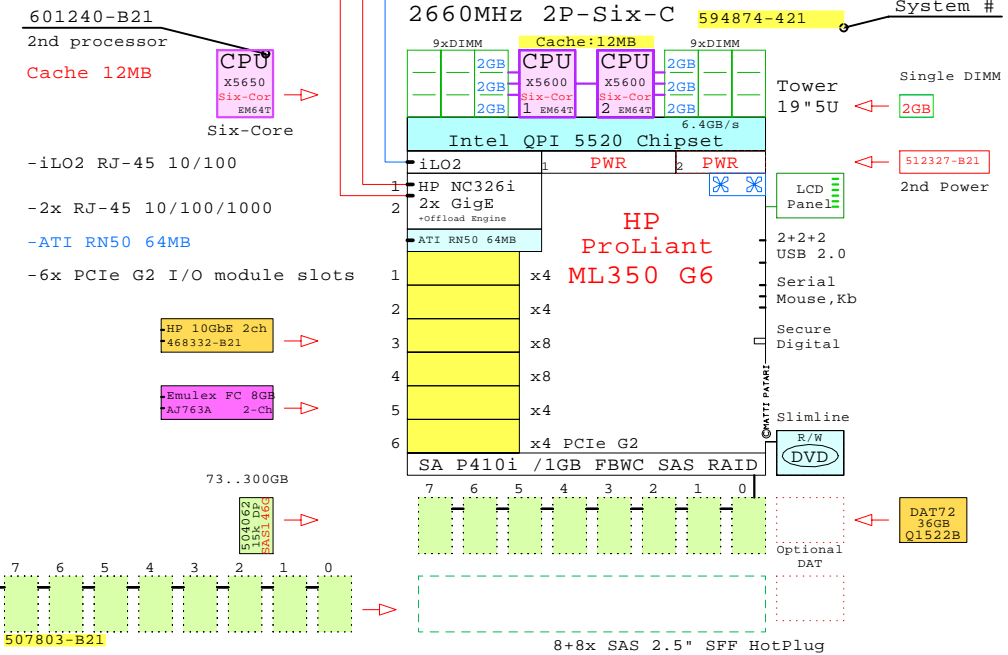

MS Windows Server 2003 and 2008  
LINUX: Red Hat, SuSE  
VMware Virtualization Software

Tip for detail printing:  
- Zoom in area of interest  
- Print, Print Current View

Golden Eggs Home:  
<http://www.goldeneggs.fi>

© 2010 Matti Patari, All rights reserved.

GOLDEN EGGS Visuals™ Helsinki	03-Jun-2010	GE-HP-ML350G6-A Matti.Patari@Goldeneggs.Fi
-------------------------------	-------------	---

HP ProLiant ML350-G6 X5650 2660Mz  
GOLDEN EGGS Visuals, Helsinki

HP ProLiant ML350-G6 Intel 5600 2P/5U

HP ML370-G6  
Xeon 5500

Internal Options:

- 495936-B21  
CPU E5540 Quad EM64T  
2nd Quad-Core E5540  
2530MHz 8MB
- 500656-B21  
2GB
- 500658-B21  
4GB
- 500662-B21  
8GB
- 500666-B21  
16GB  
DDR3-SDRAM  
1x DIMMs each
- 512327-B21  
2nd Power
- 508107-B21  
Fans: 4-5
- 512545-B21  
72GB 15k 6G SAS 2.5"  
15k DP SAS1466
- 512547-B21  
146GB 15k 6G SAS 2.5"  
15k DP SAS1466
- 507127-B21  
300GB 10k 6G SAS 2.5"  
10k DP SAS3000
- 572073-B21  
120GB SSD SATA 2.5"  
SSD SATA120
- Q1522B  
HP DAT72 Tape drive
- 412648-B21  
HP NC360T 2ch GigE  
412648-B21 2ch
- 468332-B21  
HP NC522SFP 2ch 10GbE  
468332-B21
- AH627A  
HP U320e SCSI HBA
- 462864-B21  
HP SA P410 512mb RAID  
462864-B21 BB
- AJ763A  
Emulex FC 8Gb 2-ch  
AJ763A 2-ch

Example Configuration  
x86-64

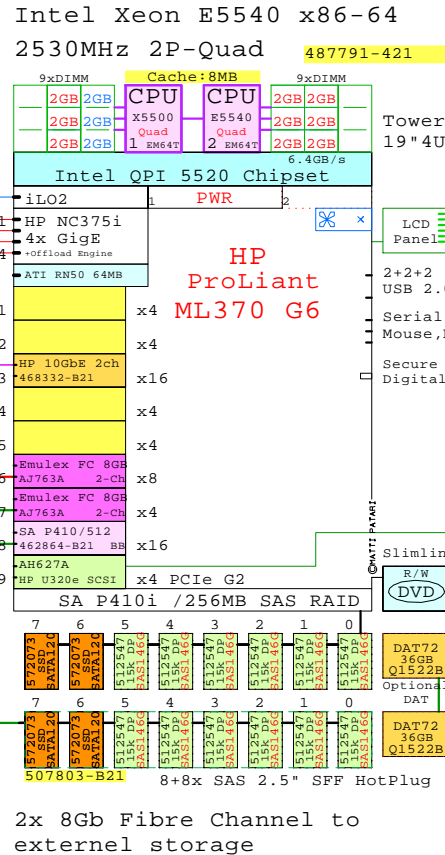

Parts list for the 2P Quad-Core HP ML370-G6 system above

Part Number	Qty	Description
1	487791-421	1 HP ML370-G6 2P I QC E5540-8MB 6GB 4U
1.1	462864-B21	1 HP Smart Array P410/512MB BBWC HBA
1.2	468332-B21	1 HP NC522SFP 10GbE DualPort NIC
1.3	495936-B21	1 Xeon QC E5540-8MB 2.53GHz for ML370G6
1.4	500656-B21	9 HP 2GB 2Rx8 PC3-10600R-9 kit 1x2GB
1.5	507803-B21	1 HP ML350/370 G6 8 SFF 2nd Driv gage
1.5.1	512547-B21	6 HP 146GB 6G 15k 2.5" SAS DualPort HDD
1.5.2	572073-B21	2 HP 120GB SATA SSD hot-plug disk 2.5"
1.6	512547-B21	6 HP 146GB 6G 15k 2.5" SAS DualPort HDD
1.7	572073-B21	2 HP 120GB SATA SSD hot-plug disk 2.5"
1.8	AH627A	1 HP U320e SCSI Bus Adapter
1.9	AJ763A	2 HP Emulex FC 8Gb 2-ch PCIe HBA
1.10	Q1522B	2 HP DAT 72 36GB internal drive

Nehalem EP  
2530MHz Quad-Core

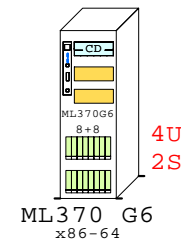
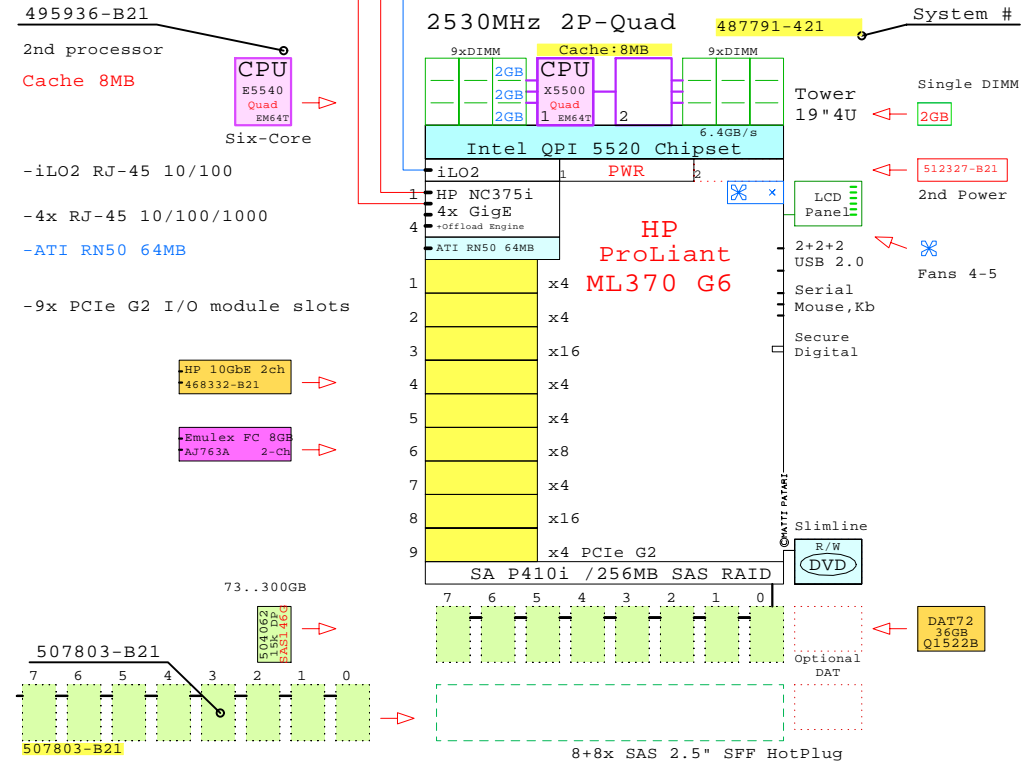

MS Windows Server 2003 and 2008  
LINUX: Red Hat, SuSE  
VMware Virtualization Software

Tip for detail printing:  
- Zoom in area of interest  
- Print, Print Current View

Golden Eggs Home:  
<http://www.goldeneggs.fi>

© 2010 Matti Patari, All rights reserved.

GOLDEN EGGS Visuals™ Helsinki	06-Jun-2010	GE-HP-ML370G6-A Matti.Patari@Goldeneggs.Fi
-------------------------------------	-------------	---

HP ProLiant ML370-G6 E5540 2530Mz  
GOLDEN EGGS Visuals, Helsinki

HP ProLiant ML370-G6 Intel 5500 2P/4U



# Welcome to GoldenEggs Visual Configurations

<http://www.goldeneggs.fi>

A picture is worth of one thousand words.  
It talks all Global languages.

x86-64 servers: **Dell IBM HP Fujitsu SUN Acer Lenovo and Cisco**

AMD Opteron 6174 x86-64

2200MHz 2P 12-Cor **DELL-R715-Axx**

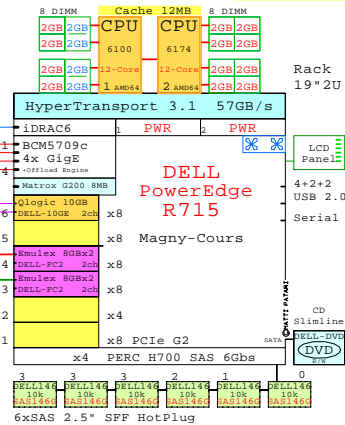

2x 8Gb Fibre Channel to external storage

Intel Xeon X5670 x86-64

2930MHz 2P-Six-C **IBM-7944-M2x**

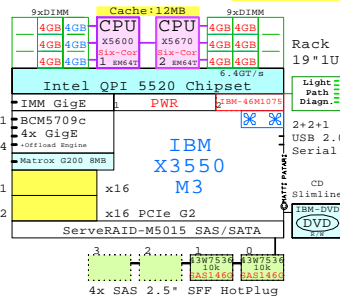

AMD Opteron 6172 x86-64

2100MHz 2P 12-Cor **573088-421 EU**

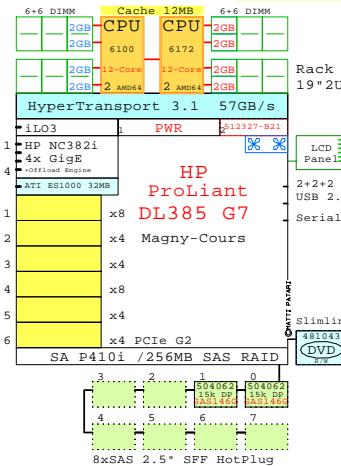

Intel Xeon X5570 x86-64

2930MHz 2P-Quad **FUJII-RX200S5A**

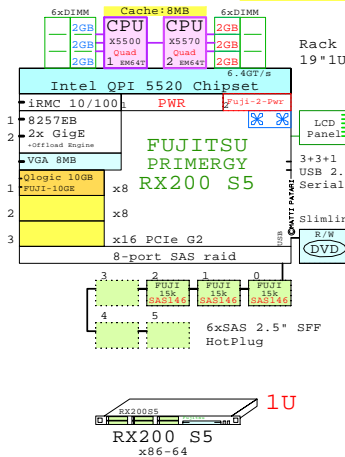

AMD Opteron 2431 x86-64

2400MHz 2P Six-C **SUN-X4140-B**

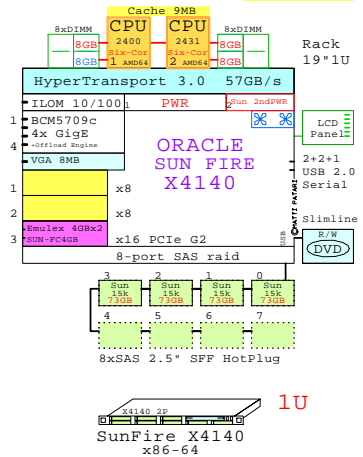

The present GoldenEggs multi vendor x86-64 website.

<http://www.goldeneggs.fi>

Older GoldenEggs are still available at:

DEC/Compaq/HP: VAX, Alpha, Storage and ProLiant Servers.

<http://h18000.www1.hp.com/info/GECPQA/>

OpenVMS.org: Alpha, Storage, ProLiant and Itanium Servers

<http://www.openvms.org/pages.php?page=GoldenEggs>

Matti.Patari@Kolumbus.Fi Helsinki,Finland

Your comments,improvements,are welcome.

Follow GoldenEggs on Twitter:

[@goldeneggsfi](https://twitter.com/goldeneggsfi)

GE-links to x86 FAMILY Pictures:

- <http://www.goldeneggs.fi/documents/GE-DELL-FAMILY-A.pdf>
- <http://www.goldeneggs.fi/documents/GE-IBM-FAMILY-A.pdf>
- <http://www.goldeneggs.fi/documents/GE-HP-FAMILY-A.pdf>
- <http://www.goldeneggs.fi/documents/GE-FUJII-FAMILY-A.pdf>
- <http://www.goldeneggs.fi/documents/GE-SUN-FAMILY-A.pdf>
- <http://www.goldeneggs.fi/documents/GE-ACER-FAMILY-A.pdf>
- <http://www.goldeneggs.fi/documents/GE-LENOVO-FAMILY-A.pdf>
- <http://www.goldeneggs.fi/documents/GE-CISCO-FAMILY-A.pdf>

GE-links to x86 COMPARE Pictures:

- <http://www.goldeneggs.fi/documents/GE-COMPARE-2P-1U-A.pdf>
- <http://www.goldeneggs.fi/documents/GE-COMPARE-2P-2U-A.pdf>
- <http://www.goldeneggs.fi/documents/GE-COMPARE-4P-4U-A.pdf>
- <http://www.goldeneggs.fi/documents/GE-COMPARE-8P-8U-A.pdf>
- <http://www.goldeneggs.fi/documents/GE-COMPARE-TOWER-A.pdf>

© 2010 Matti Patari, All rights reserved.

GOLDEN EGGS Visuals™ Helsinki	03-Jun-2011	GE-Welcomel
		Matti.Patari@Kolumbus.Fi

Welcome to Visual Configurations  
GOLDEN EGGS Visuals, Helsinki

GE-Welcomel